

JVC

BEDIENUNGSANLEITUNG

MANUEL D'INSTRUCTIONS

ISTRUZIONI

MANUAL DE INSTRUCCIONES

ИНСТРУКЦИЯ ПО ЭКСПЛУАТАЦИИ

使用说明书

DT-V17L3R

MULTI FORMAT LCD MONITOR

MONITEUR LCD MULTI-FORMAT

MONITOR LCD MULTIFORMATO

MONITOR LCD MULTIFORMATO

МУЛЬТИФОРМАТНЫЙ ЖК МОНИТОР

多格式LCD 显示器

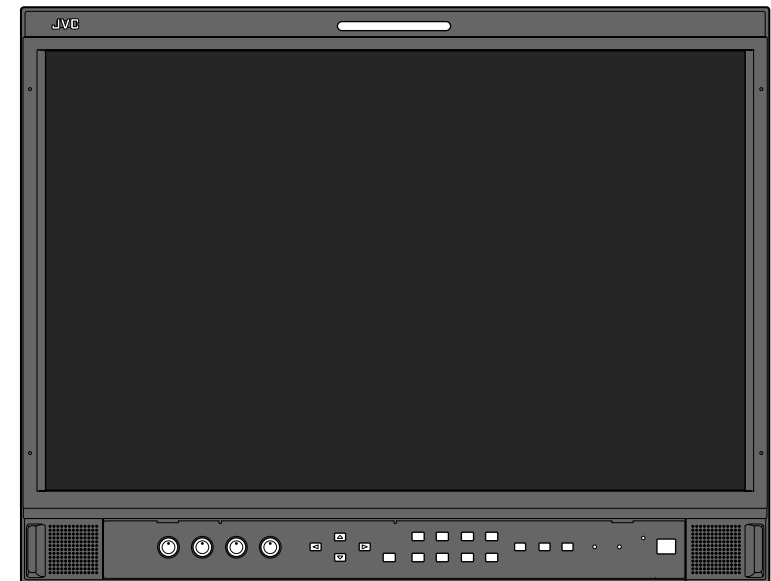

ITALIANO
FRANÇAIS
DEUTSCH
ENGLISH

ESPAÑOL
РУССКИЙ
中文





LCT2490-002A-H



DT-V17L3R

MULTI FORMAT LCD MONITOR



	CAUTION RISK OF ELECTRICAL SHOCK DO NOT OPEN	
<p>CAUTION: To reduce the risk of electric shock. Do not remove cover (or back). No user serviceable parts inside. Refer servicing to qualified service personnel.</p>		
	<p>The lightning flash with arrowhead symbol, within an equilateral triangle is intended to alert the user to the presence of uninsulated "dangerous voltage" within the product's enclosure that may be of sufficient magnitude to constitute a risk of electric shock to persons.</p>	
	<p>The exclamation point within an equilateral triangle is intended to alert the user to the presence of important operating and maintenance (servicing) instructions in the literature accompanying the appliance.</p>	

INSTRUCTIONS

Table of Contents	
Safety Precautions	2
IMPORTANT SAFEGUARDS	2
Installation.....	4
Daily Operations / Connections	6
Front panel	6
Rear panel.....	8
Available signals.....	9
Menu Configuration—MAIN MENU	10
Menu Configuration—SET-UP MENU	14
External Control.....	16
About the external control	16
Using the MAKE/TRIGGER system	17
Using the serial communication	18
Troubleshooting	19
Self-check program	20
Maintenance.....	20
Specifications	21
General.....	21
Input/output terminals.....	21
Dimensions.....	22

Safety Precautions

WARNING: TO REDUCE RISK OF FIRE OR ELECTRIC SHOCK, DO NOT EXPOSE THIS APPARATUS TO RAIN OR MOISTURE. NO OBJECTS FILLED WITH LIQUIDS, SUCH AS VASES, SHALL BE PLACED ON THE APPARATUS.

IMPORTANT SAFEGUARDS

Electrical energy can perform many useful functions. This unit has been engineered and manufactured to assure your personal safety. But **IMPROPER USE CAN RESULT IN POTENTIAL ELECTRIC SHOCK OR FIRE.** In order not to defeat the safeguards incorporated into this product, observe the following basic rules for its installation, use, and service. Please read these "IMPORTANT SAFEGUARDS" carefully before use.

- All the safety and operating instructions should be read before the product is operated.
- The safety and operating instructions should be retained for future reference.
- All warnings on the product and in the operating instructions should be adhered to.
- All operating instructions should be followed.

POWER CONNECTION

The power supply voltage rating of this product is AC 120 V (For U.S.A. and Canada) and AC 220 – 240 V (For European countries, Asian countries, and United Kingdom).

The power cord attached conforms to the following power supply voltage and countries. Use only the power cord designated to ensure safety and EMC regulations of each country.

- Not all types of power cords are supplied to this product.

For U.S.A. and Canada:
AC 120 V



For European and Asian countries:
AC 220 – 240 V



For United Kingdom:
AC 220 – 240 V



This plug will fit only into a grounded power outlet. If you are unable to insert the plug into the outlet, contact your electrician to install the proper outlet. Do not defeat the safety purpose of the grounded plug.

- This product should be operated only with the type of power source indicated on the label. If you are not sure of the type of power supply of your home, consult your product dealer or local electric power company.

Warning:

- Do not use the same power cord for AC 120 V as for AC 220 – 240 V. Doing so may cause malfunction, electric shock or fire.

Note for United Kingdom power cord only

The plug of United Kingdom power cord has a built-in fuse. When replacing the fuse, be sure to use only a correctly rated approved type, re-fit the fuse cover. (Consult your dealer or qualified personnel.)

How to replace the fuse

Open the fuse compartment with the blade screwdriver, and replace the fuse.

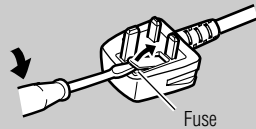

Warning: This is a class A product. In a domestic environment this product may cause radio interference in which case the user may be required to take adequate measures.

- Before connecting other products such as VCR's and personal computers, you should turn off the power of this product for protection against electric shock.
- Do not use attachments not recommended by the manufacturer as they may be hazardous.
- **When replacement parts are required**, be sure the service technician has used replacement parts specified by the manufacturer or equivalents. Unauthorized substitutions may result in fire, electric shock, or other hazards.
- **Upon completion of any service or repairs to this product**, ask the service technician to perform safety checks to determine that the product is in proper operating condition.

Under the following conditions,

1. Turn off the power.
 2. Unplug this product from the wall outlet.
 3. Refer service to qualified service personnel.
- a) When the product emits smoke or unusual smell.
 - b) When the product exhibits a distinct change in performance—for example, no picture.
 - c) If liquid has been spilled, or objects have fallen on the product.
 - d) If the product has been exposed to rain or water.
 - e) If the product has been dropped or damaged in any way.
 - f) When the power supply cord or plug is damaged.

- Do not install this product in the following places:
 - in a damp or dusty room
 - where the product is exposed to soot or steam, such as near the cooking counter or a humidifier
 - near heat sources
 - where condensation easily occurs, such as near the window
 - Do not place this product on an unstable cart, stand, or table. The product may fall, causing serious injury to a child or adult, and serious damage to the product.
- The product should be mounted according to the manufacturer's instructions, and should use a mount recommended by the manufacturer.
- Do not use this product near water.
 - Be sure to install the product in the place where proper temperature and humidity are kept (see "Operating conditions" on page 21).
- This product becomes hot during its use. Take enough care when handling the product.

Do not attempt to service this product yourself, as opening or removing covers may expose you to dangerous voltages and other hazards. Refer all service to qualified service personnel.

- The AC power supply is controlled by turning on/off the POWER switch on the rear panel. If the product is installed in a place where you cannot easily turn on/off the POWER switch, control the AC power supply by plugging/unplugging the power cord into/from the AC outlet. In this case, install the product as close to the AC outlet as possible, and leave enough space for plugging/unplugging the power cord. If the product is installed in a place where you cannot easily plug/unplug the power cord, equip an easily accessible device to the wiring of the building for turning on/off the power.
- When the product is left unattended and unused for a long period of time, unplug it from the wall outlet and disconnect the cable system.
- Do not overload wall outlets, extension cords, or convenience receptacles on other equipment as this can result in a risk of fire or electric shock.
- Use only the accessory cord designed for this product to prevent shock.

- Slots and openings in the cabinet are provided for ventilation. These ensure reliable operation of the product and protect it from overheating. These openings must not be blocked or covered.
- Never push objects of any kind into this product through openings as they may touch dangerous voltage points or short-circuit the parts, which could result in a fire or electric shock.
- Never spill liquid of any kind on the product.
- Never place anything on the product. (Placing liquids, naked flames, cloths, paper, etc. on the product may cause a fire.)
- Do not apply any strong shock to the LCD panel. (Do not hit any object against it or push it with a sharp-pointed tool.)
- Do not put heavy objects on the product.
- Do not step on or hang on the product.

Caution for use of the product in the high temperature

Do not use the product in places of high temperature; otherwise, parts of this product or the LCD panel may be damaged. This product is equipped with a temperature sensor to give warning if the temperature becomes too high. If the temperature exceeds the range of normal use, "TEMP. OVER" is displayed, and the power is turned off automatically if the temperature becomes any higher. In this case, move the product to a place of low temperature to let it cool down.

U.S.A. only

FCC NOTICE

CAUTION: Changes or modifications not approved by JVC could void the user's authority to operate the equipment.

NOTE: This equipment has been tested and found to comply with the limits for a Class A digital device, pursuant to Part 15 of the FCC Rules. These limits are designed to provide reasonable protection against harmful interference when the equipment is operated in a commercial environment. This equipment generates, uses, and can radiate radio frequency energy and, if not installed and used in accordance with the instruction manual, may cause harmful interference to radio communications. Operation of this equipment in a residential area is likely to cause harmful interference in which case the user will be required to correct the interference at his own expense.

IMPORTANT RECYCLING INFORMATION

This product has a fluorescent lamp that contains mercury. Disposal of these materials may be regulated in your community due to environmental considerations. For disposal or recycling information, please contact your local authorities or for USA, the Electronic Industries Alliance: <http://www.eiae.org>

WARNING: TO PREVENT FIRE OR SHOCK HAZARDS, DO NOT EXPOSE THIS APPARATUS TO RAIN OR MOISTURE.

WARNING: THIS APPARATUS MUST BE CONNECTED TO A MAINS SOCKET OUTLET WITH A PROTECTIVE EARTHING CONNECTION.

CAUTION: DANGER OF EXPLOSION IF BATTERY IS INCORRECTLY REPLACED. REPLACE ONLY WITH THE SAME OR EQUIVALENT TYPE.

IMPORTANT SAFETY INSTRUCTIONS

- 1) Read these instructions.
- 2) Keep these instructions.
- 3) Heed all warnings.
- 4) Follow all instructions.
- 5) Do not use this apparatus near water.
- 6) Clean only with dry cloth.
- 7) Do not block any ventilation openings. Install in accordance with the manufacturer's instructions.
- 8) Do not install near any heat sources such as radiators, heat registers, stoves, or other apparatus (including amplifiers) that produce heat.
- 9) Do not defeat the safety purpose of the polarized or grounding-type plug. A polarized plug has two blades with one wider than the other. A grounding type plug has two blades and a third grounding prong. The wide blade or the third prong are provided for your safety. If the provided plug does not fit into your outlet, consult an electrician for replacement of the obsolete outlet.
- 10) Protect the power cord from being walked on or pinched particularly at plugs, convenience receptacles, and the point where they exit from the apparatus.
- 11) Only use attachments/accessories specified by the manufacturer.
- 12) Use only with the cart, stand, tripod, bracket, or table specified by the manufacturer, or sold with the apparatus. When a cart is used, use caution when moving the cart/apparatus combination to avoid injury from tip-over.
- 13) Unplug this apparatus during lightning storms or when unused for long periods of time.
- 14) Refer all servicing to qualified service personnel. Servicing is required when the apparatus has been damaged in any way, such as power-supply cord or plug is damaged, liquid has been spilled or objects have fallen into the apparatus, the apparatus has been exposed to rain or moisture, does not operate normally, or has been dropped.
- 15) Apparatus shall not be exposed to dripping or splashing and no objects filled with liquids, such as vases, shall be placed on the apparatus.
- 16) Batteries shall not be exposed to excessive heat such as sunshine, fire or the like.
- 17) When discarding batteries, environmental problems must be considered and the local rules or laws governing the disposal of these batteries must be followed strictly.



European Union only

Dear Customer,

This apparatus is in conformance with the valid European directives and standards regarding electromagnetic compatibility and electrical safety.

European representative of Victor Company of Japan, Limited is:

JVC Technical Services Europe GmbH
Postfach 10 05 04
61145 Friedberg
Germany

Information for Users on Disposal of Old Equipment



Attention:

This symbol is only valid in the European Union.

[European Union]

This symbol indicates that the electrical and electronic equipment should not be disposed as general household waste at its end-of-life. Instead, the product should be handed over to the applicable collection point for the recycling of electrical and electronic equipment for proper treatment, recovery and recycling in accordance with your national legislation.

By disposing of this product correctly, you will help to conserve natural resources and will help prevent potential negative effects on the environment and human health which could otherwise

be caused by inappropriate waste handling of this product. For more information about collection point and recycling of this product, please contact your local municipal office, your household waste disposal service or the shop where you purchased the product.

Penalties may be applicable for incorrect disposal of this waste, in accordance with national legislation.

(Business users)

If you wish to dispose of this product, please visit our web page www.jvc-europe.com to obtain information about the take-back of the product.

[Other Countries outside the European Union]

If you wish to dispose of this product, please do so in accordance with applicable national legislation or other rules in your country for the treatment of old electrical and electronic equipment.

EMC Supplement

This equipment is in conformity with the provisions and protection requirements of the corresponding European Directives. This equipment is designed for professional video appliances and can be used in the following environments:

- Controlled EMC environment (for example purpose built broadcasting or recording studio), and rural outdoors environment (far away from railways, transmitters, overhead power lines, etc.)

In order to keep the best performance and ensure electromagnetic compatibility, we recommend to use cables not exceeding the following length:

Cable	Length
Power cord (attached cable (H05VV-F 3 x 0.75 mm ²))	2.0 m
Signal cable (coaxial cable)	2.0 m
DVI cable (shielded cable)	2.0 m
RS-232C cable (shielded cable) (A straight cable with a D-sub 9-pin connector)	2.0 m
RS-485 cable (twist pair cable) (A straight LAN cable)	2.0 m
REMOTE cable (twist pair cable) (A straight LAN cable)	2.0 m

The inrush current of this apparatus is 8.947 ampere.

CAUTION

In case where the strong electromagnetic waves or magnetism are near the signal cable, the picture will contain noise. In such cases, please keep the cable away from the sources of the disturbance.

CAUTION

- Do not rest your arm on the monitor or lean against the monitor.
- Do not touch the LCD panel when installing the monitor.
- Be sure to install the monitor securely to prevent the monitor from falling over, which may cause damage to the monitor or injury.

You can place the monitor in the following two ways when using it on the supplied stand.

You can tilt the monitor as follows.

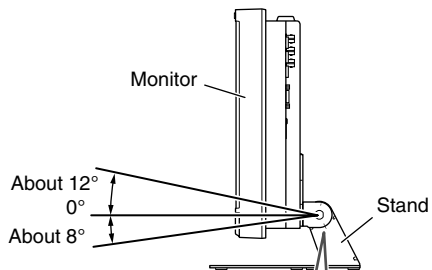

- When the monitor is not tilted (0°), the guidelines align as illustrated below.

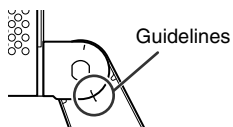

- You can select the stand height—higher position or lower position (see “To adjust the stand height” on page 5).

CAUTION

- Be careful not to pinch your fingers in the gap between the monitor and the stand.
- When the stand plate is attached to the lower position of the stand body, you cannot tilt the monitor downward.

When the stand plate is attached to the higher position of the stand body (see “To adjust the stand height” on page 5), you can place the monitor as illustrated below.

- 1 Remove the screws on the right side of the stand (see the illustration below), then lift the stand up by about 144°.

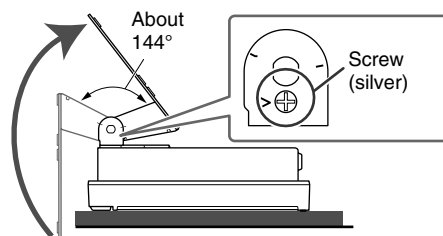

- 2 Attach the removed screws and place the monitor as illustrated below.

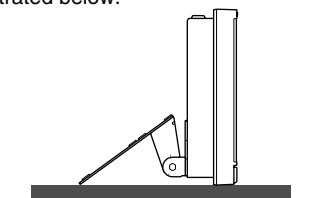

- To place the monitor as illustrated on the left again, remove the screws on the right side of the stand, return the monitor angle to 0°, then reattach the removed screws.

CAUTION

- When lifting up the stand...
 - lay the monitor on a cloth with the LCD panel facing down to prevent the LCD panel from being damaged.
 - be careful not to pinch your fingers in the moving parts.
- Make sure of lifting the stand up until it stops (about 144°); otherwise the monitor may fall over.
- Place the monitor on a mat to avoid scratching the table surface.
- Do not lift up the stand when the stand plate is attached to the lower position of the stand body.

To detach the stand

CAUTION

Lay the monitor on a cloth with the LCD panel facing down to prevent the LCD panel from being damaged.

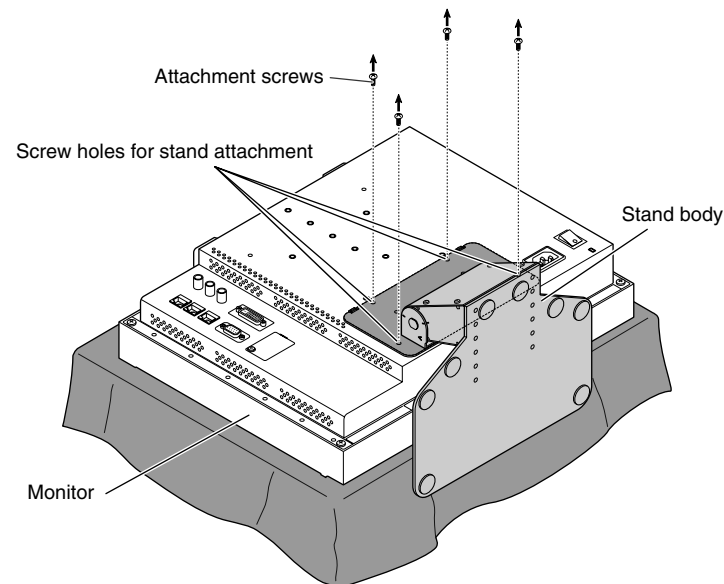

To install the stand

When attaching the stand to the monitor, insert the guides of the stand into the guide holes on the monitor to place the stand in the correct position. Then fix the stand firmly with the attachment screws.

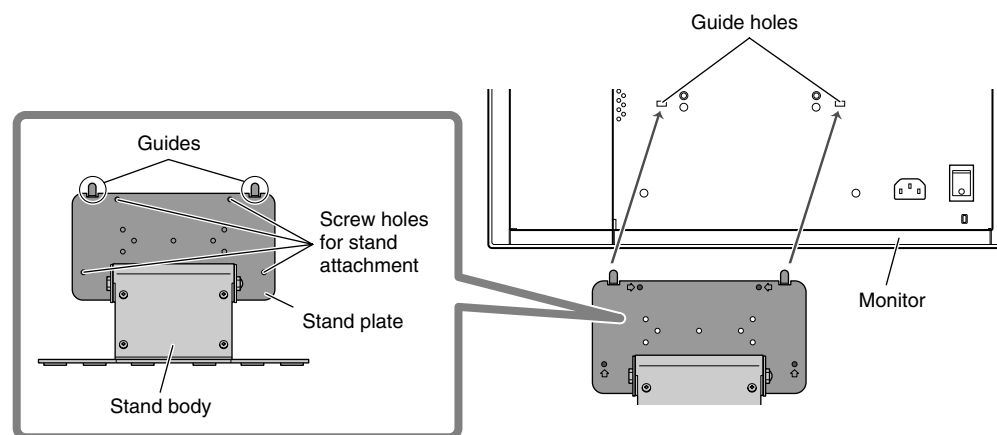

To adjust the stand height

To change the stand height, detach the stand from the monitor (see "To detach the stand" on page 4). Then, change the position of the stand plate according to the stand height you want by choosing the screw holes to use.

<Higher position>

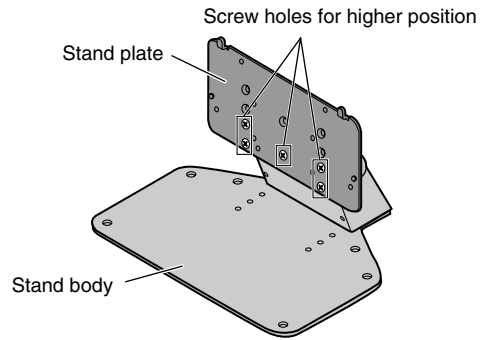

<Lower position>

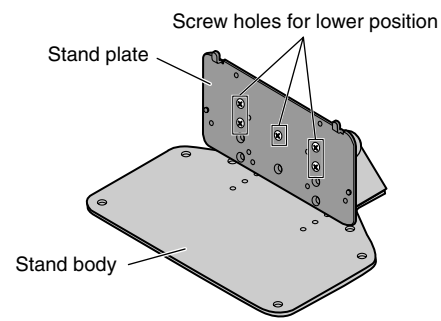

To prevent an accidental fall

Fix the monitor to a wall by using strings.

Fixing the monitor

Attach the hook (not provided) to the VESA mounting holes on the rear panel (use the two holes on the upper side) using M4 x 10 mm screws (not provided). Bind the hooks on the rear panel of the monitor to a wall or a pillar using durable string.

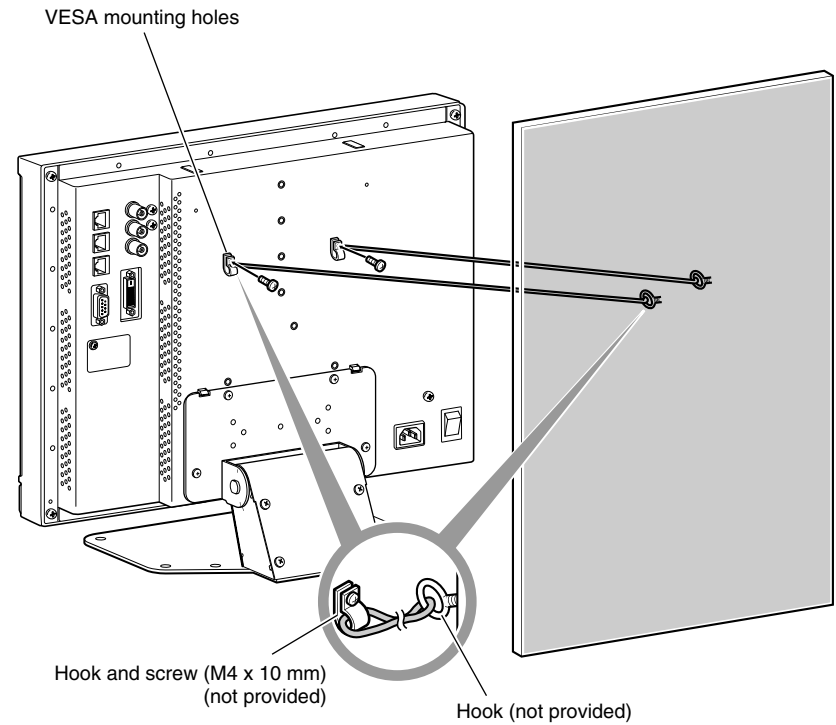

■ Front panel

Tally lamp

This lamp is controlled by the tally function of the MAKE/TRIGGER terminal.

- You can select the color of the tally lamp from “GREEN” or “RED”.

☞ “TALLY SELECT” in “FUNCTION SETTING” on page 14 and “External Control” on page 16

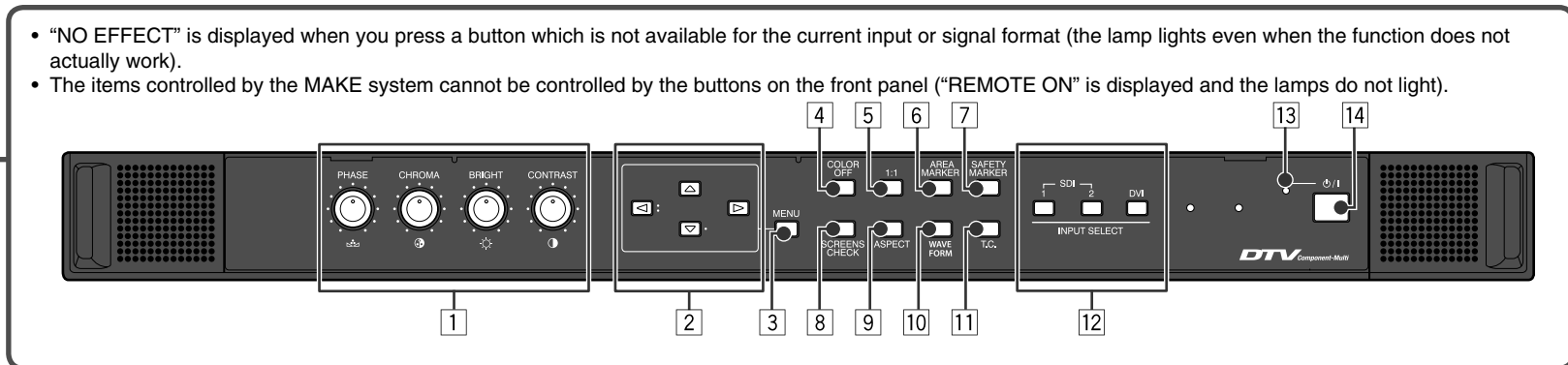
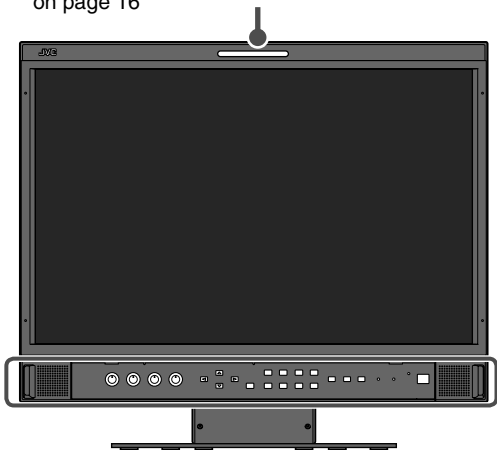

- “NO EFFECT” is displayed when you press a button which is not available for the current input or signal format (the lamp lights even when the function does not actually work).
- The items controlled by the MAKE system cannot be controlled by the buttons on the front panel (“REMOTE ON” is displayed and the lamps do not light).

1 Picture adjustment knob

PHASE: Adjusts the picture hue.
CHROMA: Adjusts the picture color density.
BRIGHT: Adjusts the picture brightness.
CONTRAST: Adjusts the picture contrast.

2 </>/△/▽ buttons

Selects or adjusts menu items when a menu screen is displayed. (☞ “Menu Operations” on page 7)
 • Pressing </> button while holding ▽ button displays the SET-UP MENU. (☞ “Menu Operations” on page 7)

3 MENU button

Activates/deactivates the display of the MAIN MENU. (☞ “Menu Operations” on page 7)

4 COLOR OFF button/lamp

Displays only the luminance signal.
 • This function does not work for RGB input signals.

5 1:1 button/lamp

Displays the picture in the original resolution of the input signal.
 • The aspect ratio of the picture may change depending on the input signal.

6 AREA MARKER button/lamp

Displays/hides the area marker.
 • Select the style of the area marker in “MARKER” of the MAIN MENU (☞ page 11).
 • This function works only when displaying the picture in 16:9 aspect ratio.
 • This function does not work when “AREA MARKER” or “R-AREA MARKER” is set to “OFF” in “MARKER.”

7 SAFETY MARKER button/lamp

Displays/hides the safety marker.
 • Adjust the area of the safety marker in “MARKER” of the MAIN MENU (☞ page 11).
 • This function does not work when displaying the picture in the 1:1 mode.
 • This function does not work when “SAFETY MARKER” or “R-SAFETY MARKER” is set to “OFF” in “MARKER.”

8 SCREENS CHECK button/lamp

Displays only the selected element (R, G, or B) of the video signal.
 • Each time you press this button, the screen changes in the following order.

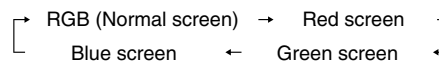

9 ASPECT button/lamp

Changes the aspect ratio of the picture from 4:3 to 16:9 when the picture of 16:9 aspect ratio is squeezed into 4:3 format signal.
 • To return to 4:3, press the button again.
 • This function does not work when displaying the picture in the 1:1 mode.

10 WAVE FORM button/lamp

Displays/hides the indication of the wave form monitor.
 • Adjust the settings of the wave form monitor in “WAVE FORM SETTING” of the MAIN MENU (☞ page 13).

11 T.C. (time code) button/lamp

Activates/deactivates the display of the time data (time code) contained in the SDI signal. (☞ “On the Information Display” on page 7)

12 INPUT SELECT buttons/lamps

Selects an input.
SDI 1: E. AUDIO HD/SD SDI (IN 1) terminal
SDI 2: E. AUDIO HD/SD SDI (IN 2) terminal
DVI: DVI-D (HDCP) terminal
 • The lamp for the selected input lights.

13 Power lamp

Unlit: The monitor is completely off (the AC plug is disconnected or the POWER switch on the rear panel is turned off).
Lights in Green: The monitor is on.
Lights in orange: The monitor is off (on standby).
Flashes in orange: The monitor is in the P. SAVE (power save) mode (☞ “NO SYNC ACTION” in “SYNC FUNCTION” on page 13).

14 Power button

Turns on and off (on standby) the monitor.
 • The POWER switch is equipped on the rear panel of the monitor (☞ 6 on page 8).

Menu Operations

1 Display the menu.

To display the MAIN MENU

➔ Press MENU button.

To display the SET-UP MENU

➔ Press ◀ button while holding ▽ button.

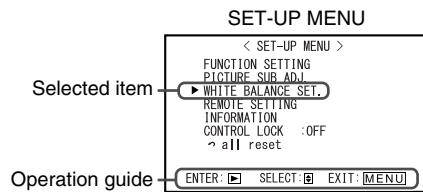
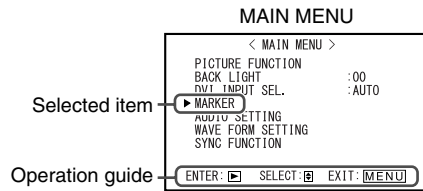

2 Press △ ▽ buttons to select an item, then press ▷ button.

• For some items, adjustments will be made by pressing ◀▷.

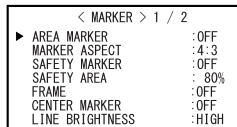

Ex.: When "MARKER" in the MAIN MENU is selected

3 Press △ ▽ buttons to select an item, then press ◀▷ buttons to make adjustments.

4 Press MENU button to finish the menu operation.

• Pressing MENU button repeatedly deactivates the display of the menu.

On the Information Display

The monitor displays the information below.

- Make the setting to display/hide each information using the MENU with the exception of [5], controlled with T.C. button (☞ [11] on page 6).
- Select the position of the information display (☞ "POSITION" in "INFORMATION" on page 15).

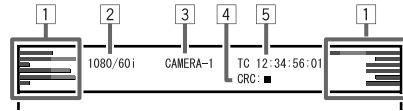

1 Audio level meter

- Not displayed when "LEVEL METER ch" is set to "OFF." (☞ "AUDIO SETTING" on page 12)

2 Signal format

- Displayed when "STATUS DISPLAY" is set to "ON." (☞ "INFORMATION" on page 15)
- For the contents displayed, see "On the signal format" on the right and "Available signals" on page 9.

3 Source name assigned in "CHARACTER SET."

- Displayed when "SOURCE ID" is set to "ON."
- Displayed in large letters when "STATUS DISPLAY" is set to "OFF" or "AUTO." (☞ "INFORMATION" on page 15)

4 CRC error indication

- Displayed when "CRC ERROR" is set to "ON." (☞ "INFORMATION" on page 15)
- A red square is displayed when an error occurs.

5 Time code

- When the input signal includes no time code, "TC - - - - -" is displayed. (☞ "[11] T.C. (time code) button/lamp" on page 6)
- When any information of [1], [2], [3], or [4] above is displayed while signals come in from equipment other than a computer, the picture is displayed without overlapping the information display area. However, the information display will overlap with the picture when...
 - displaying the picture with higher resolution than the resolution of the panel in 1:1 mode.
 - "SD4:3 LARGE" setting is "ON." (☞ "FUNCTION SETTING" on page 14).

On the Status Display

If you press the INPUT SELECT button currently lit, the status of the input signal is displayed for about 3 seconds.

- Make the setting to display/hide the status in "STATUS DISPLAY" of the "INFORMATION" (☞ page 15).
- When "STATUS DISPLAY" is set to "AUTO" or "ON," the status below is also displayed in the following cases:
 - When you change the input
 - When the signal condition of the current input changes
 - When you turn on the monitor
- When "STATUS DISPLAY" is set to "ON," the signal format will remain displayed 3 seconds after the status is displayed.

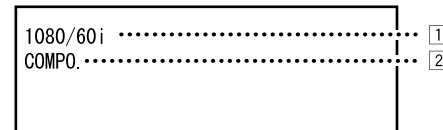

1 Signal format

- For the contents displayed, see "On the signal format" on the right and "Available signals" on page 9.

2 Signal format of DVI input

- ☞ "DVI INPUT SEL." on page 10

On the signal format

The following messages appear depending on the type of input signals and their conditions.

When a DVI-D signal protected with HDCP is input
➔ "*" (at the end of the indication)

When no video signal comes in
➔ "NO SYNC"

When a noncompliant video signal comes in
➔ "Out of range"

■ Rear panel

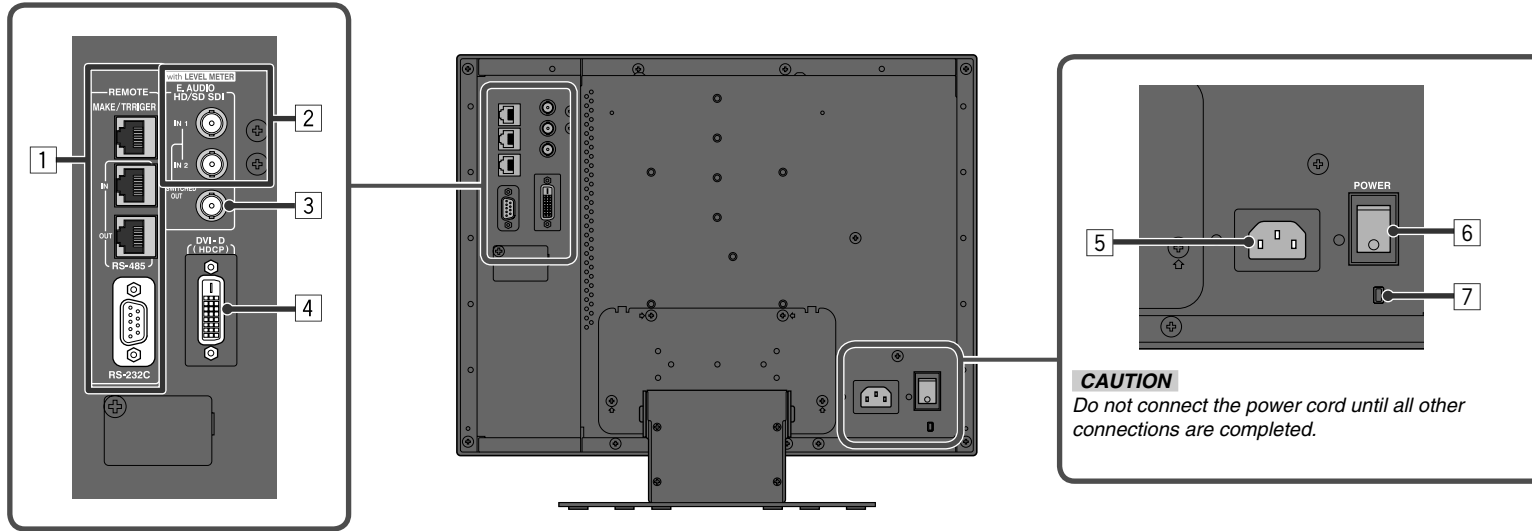

1 REMOTE terminal

Terminal for controlling the monitor by an external control. (☞ “External Control” on page 16)

2 E. AUDIO HD/SD SDI (IN 1, IN 2) terminals (BNC)

Input terminals for the HD/SD SDI signals.

- The terminals accept also EMBEDDED AUDIO signals including up to 12 audio channels with a sampling frequency of 48 kHz.

Using the audio level meter

You can check the conditions of the current EMBEDDED AUDIO signals in the audio level meter. (☞ “On the Information Display” on page 7, “LEVEL METER SETTING” in “AUDIO SETTING” on page 12).

3 E. AUDIO HD/SD SDI (SWITCHED OUT) terminal (BNC)

Output terminal for the HD/SD SDI signals.

- The SDI signals of the current input (SDI 1 or SDI 2) are re-clocked, then emitted.
- When an input other than SDI 1 and SDI 2 is selected, the SDI signal of the input selected last time is emitted from this terminal.
- The signals are emitted from this terminal only when the monitor is on or in “P.SAVE” (power save) mode.

4 DVI-D (HDCP) terminal

Input terminal for the DVI-D signal compatible with HDCP.

- When the picture is not displayed correctly, change the setting of “DVI INPUT SEL.” (☞ page 10).

5 AC inlet

AC power input connector.

Connect the provided AC power cord to an AC outlet.

- Attach the provided power cord holder to prevent accidental disconnection of the AC power cord (☞ “Attaching the power cord holder” on the right).

6 POWER switch

Turns AC power on or off.

- You need to press button (☞ 14 on page 6) to use the monitor after turning on the POWER switch.

7 Security slot

Attach a security wire to this slot.

Note for connections

- Before making any connections, turn off all the equipment.
- Use a cord whose plugs correctly match the terminals on this monitor and the equipment.
- Plugs should be firmly inserted; poor connections could cause noise.
- When unplugging a cord, be sure to grasp its plug and pull it out.
- DO NOT connect the power cord until all connections are complete.
- Refer also to the user manual of each piece of equipment.

CAUTION

Do not connect the power cord until all other connections are completed.

Attaching the power cord holder

The provided power cord holder prevents accidental disconnection of the AC power cord from the AC inlet.

- The power cord holder consists of two parts, a case and a cover.

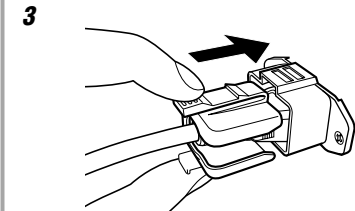
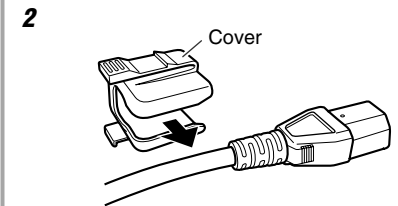
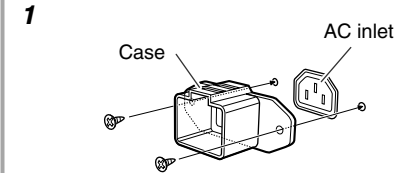

To detach the cover

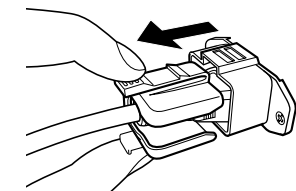

CAUTION

- Use only the provided screws.
- Make sure the plug will not be pulled out after the cover is attached to the case.

Available signals

The following signals are available for this monitor.

Video signals

No.	Signal name	Signal format shown in the status display (see page 7)	Input terminal	
			E. AUDIO HD/SD SDI (IN 1, IN 2)*1	DVI-D (HDCP) (Digital component/digital RGB)
1	480/60i	480/60i	√	√
2	576/50i	576/50i	√	√
3	480/60p	480/60p	—	√
4	576/50p	576/50p	—	√
5	640*480/60p	640*480/60p	—	√
6	720/60p	720/60p	√	√
7	720/50p	720/50p	√	√
8	720/30p	720/30p	√	—
9	720/25p	720/25p	√	—
10	720/24p	720/24p	√	—
11	1080/60i	1080/60i	√	√
12	1035/60i	1035/60i	√	√*2
13	1080/50i	1080/50i	√	√
14	1080/60p	1080/60p	—	√
15	1080/50p	1080/50p	—	√
16	1080/30p	1080/30p	√	√
17	1080/25p	1080/25p	√	√
18	1080/24p	1080/24p	√	√
19	1080/30psF	1080/60i	√*2	—
20	1080/24psF	1080/24psf	√	—

*1 Compatible with EMBEDDED AUDIO signals

*2 The signal is recognized as 1080/60i.

√: Acceptable
—: Not acceptable

Computer signals (preset)

DVI-D (HDCP) terminals

No.	Signal name	Resolution		Frequency		Scan system
		Horizontal	Vertical	Horizontal (kHz)	Vertical (Hz)	
1	VGA60	640	480	31.5	59.9	Non-interlace
2	WVGA60	852	480	31.5	59.9	Non-interlace
3	SVGA60	800	600	37.9	60.3	Non-interlace
4	XGA60	1024	768	48.4	60.0	Non-interlace
5	WXGA (1280)	1280	768	47.8	60.0	Non-interlace
6	WXGA+60	1440	900	55.9	60.0	Non-interlace
7	SXGA60*3	1280	1024	64.0	60.0	Non-interlace
8	WSXGA+60*3	1680	1050	65.2	60.0	Non-interlace
9	UXGA60*3	1600	1200	75.0	60.0	Non-interlace
10	WUXGA60*3	1920	1200	74.0	60.0	Non-interlace
11	720/60p	1280	720	45.0	60.0	Non-interlace
12	1080/60p*3	1920	1080	67.5	60.0	Non-interlace
13	720/50p	1280	720	37.5	50.0	Non-interlace
14	1080/50p*3	1920	1080	56.25	50.0	Non-interlace

*3 When No. 7–10, 12 and 14 signals come in, thin lines will become obscured because their signal resolution is higher than the screen resolution.

- Non-preset signals may not be displayed normally even if their frequency is within the acceptable range (see “Horizontal/vertical frequency (computer signal)” on page 21).
- When a preset signal comes in, the signal format is shown on the status display. For other signals, the resolution is shown.

Specification of the DVI-D (HDCP) terminal

Connect it to the DVI-D output terminal on a personal computer.

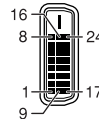

Pin No.	Input signal	Pin No.	Input signal	Pin No.	Input signal
1	T.M.D.S Data 2–	9	T.M.D.S Data 1–	17	T.M.D.S Data 0–
2	T.M.D.S Data 2+	10	T.M.D.S Data 1+	18	T.M.D.S Data 0+
3	T.M.D.S Data 2 shield	11	T.M.D.S Data 1 shield	19	T.M.D.S Data 0 shield
4	NC	12	NC	20	NC
5	NC	13	NC	21	NC
6	DDC Clock	14	+5 V Power	22	T.M.D.S Clock shield
7	DDC Data	15	GND	23	T.M.D.S Clock+
8	NC	16	Hot Plug Detect	24	T.M.D.S Clock–

For the operation procedure, see page 7.

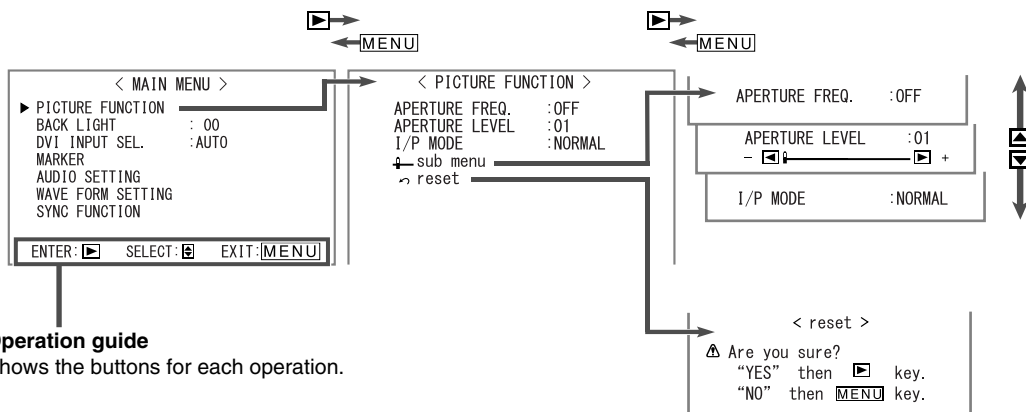

Operation guide
Shows the buttons for each operation.

- The menu automatically disappears in about 30 seconds after the previous operation.
- Some items may not appear on the menu depending on the input or the input signal.
- The items controlled by the MAKE system do not appear on the menu.

PICTURE FUNCTION

Setting for the picture quality

Item	To do	Setting value
APERTURE FREQ.*1	Select the frequency of the luminance signal compensated in "APERTURE LEVEL."	OFF, LOW, HIGH
APERTURE LEVEL*1	Compensate the frequency response of the luminance signal of the video signal.	01 – 10
I/P MODE	Selects a proper mode corresponding to the input picture.	NORMAL, CINEMA, FIELD
sub menu	Display the sub menu which enables you to adjust the items of "PICTURE FUNCTION" while viewing the actual picture.	
reset	Restore the default settings for all the items in "PICTURE FUNCTION."	

*1 Memorized for each input.

BACK LIGHT Setting value: -20 – +20

Adjusts the brightness of the display.

DVI INPUT SEL. Setting value: AUTO, MODE1, MODE2, MODE3

When "AUTO" is selected, the format of signals come in to the DVI-D (HDCP) terminal is automatically recognized. (Normally, select "AUTO.")

- Select "MODE1", "MODE2" or "MODE3" when the picture is not displayed correctly with "AUTO."
- DVI-D input of the monitor is compatible with HDCP.

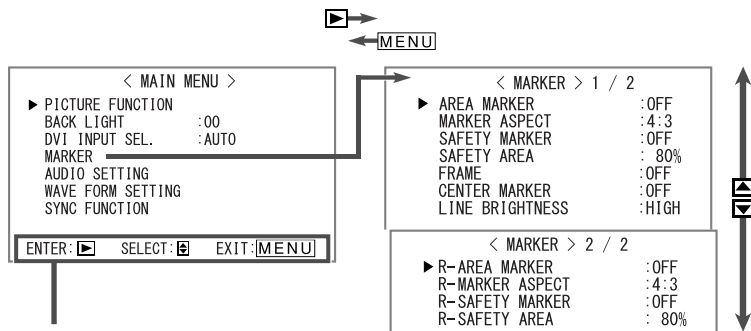

Operation guide

Shows the buttons for each operation.

- The menu automatically disappears in about 30 seconds after the previous operation.
- Some items may not appear on the menu depending on the input or the input signal.
- The items controlled by the MAKE system do not appear on the menu.

MARKER^{*1*2}

Settings for marker functions

1/2

Item	To do	Setting value
AREA MARKER^{*3}	Activate/deactivate the area marker and select the style of it.	☞ "NOTE"
MARKER ASPECT^{*3}	Select the aspect ratio of the area marker.	4:3, 14:9, 13:9, 2.35:1, 1.85:1, 1.66:1
SAFETY MARKER	Activate/deactivate the safety marker and select the style of it.	☞ "NOTE"
SAFETY AREA	Adjust the area of the safety marker.	80% – 100%
FRAME	Displays/hides the frame indicating the area of the specified aspect ratio.	OFF, ON
CENTER MARKER	Displays/hides the marker indicating the center position of the picture.	OFF, ON
LINE BRIGHTNESS	Adjust the brightness of the marker.	HIGH, LOW

2/2

Item	To do	Setting value
R-AREA MARKER^{*3}	Activate/deactivate the area marker and select the style of it.	☞ "NOTE"
R-MARKER ASPECT^{*3}	Select the aspect ratio of the area marker.	4:3, 14:9, 13:9, 2.35:1, 1.85:1, 1.66:1
R-SAFETY MARKER	Activate/deactivate the safety marker and select the style of it.	☞ "NOTE"
R-SAFETY AREA	Adjust the area of the safety marker.	80% – 100%

- The area marker or the safety marker is displayed by using AREA MARKER or SAFETY MARKER button, or external control.
- Select either non-"R-" items or "R-" items to activate by using external control (☞ "External Control" on page 16).
- When a picture is displayed in 4:3 aspect ratio, the safety marker for the 4:3 area is displayed.
- To display the safety marker for the area of a picture displayed in 16:9 aspect ratio, hide the area marker. (☞ "NOTE")

^{*1} Memorized for each input.

^{*2} Not displayed when picture is displayed in the 1:1 mode.

^{*3} Displayed only when picture is displayed in 16:9 aspect ratio.

NOTE

Setting of "AREA MARKER", "SAFETY MARKER", "R-AREA MARKER", "R-SAFETY MARKER"

The setting values and features are as follows.

OFF: Deactivate the marker.

LINE: Displays the area with an outline.

HALF: The area outside the specified aspect ratio of the screen is displayed at 50% transparency.

HALF+L: The area of the specified aspect ratio of the screen is indicated by an outline, and the area outside of that is displayed at 50% transparency.

BLK.: The area outside the specified aspect ratio of the screen is black. Only the portion of the picture within the designated area is displayed.

BLK. +L: The area of the specified aspect ratio of the screen is indicated by an outline, and the area outside of that becomes black so that only the area inside the line is displayed.

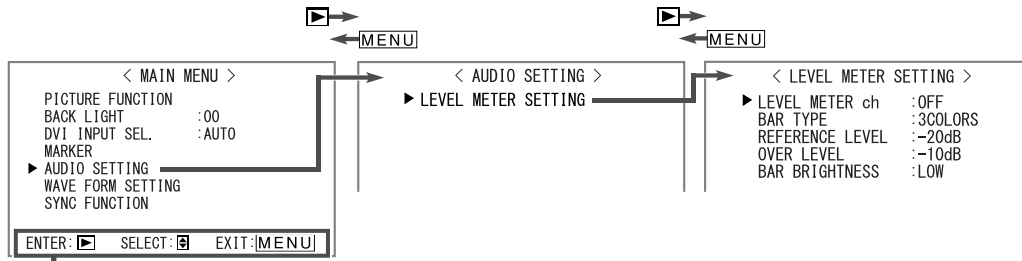

Operation guide
Shows the buttons for each operation.

- The menu automatically disappears in about 30 seconds after the previous operation.
- Some items may not appear on the menu depending on the input or the input signal.
- The items controlled by the MAKE system do not appear on the menu.

AUDIO SETTING

Settings for the EMBEDDED AUDIO signals and level meter

Item	To do	Setting value
LEVEL METER SETTING*<!--1</b-->	Adjust the level meter display for the EMBEDDED AUDIO signals.	Ⓜ "NOTE"
LEVEL METER ch	Select how the audio channels are displayed on the level meter.	OFF, LINE (Displays the channels 1 – 6 at the left of the screen and 7 – 12 at the right.), DIVIDE (Displays the odd channels at the left of the screen and the even channels at the right.)
BAR TYPE	Select the color of the level meter display.	3COLORS (3 colors to indicate variations in input levels), W.100 (white)
REFERENCE LEVEL	Select the standard input level indicated on the level meter.	-20dB, -18dB
OVER LEVEL	Select the input level's lower limit indicated in red for the "3COLORS" display.	-10dB, -8dB, -6dB, -4dB, -2dB
BAR BRIGHTNESS	Select the brightness of the level meter.	LOW, HIGH

*1 Memorized for each input.

NOTE

Example of the level meter display—Level meter position and audio channels

Ex.: When "LEVEL METER ch" is set to "LINE" and "BAR TYPE" is set to "3COLORS"

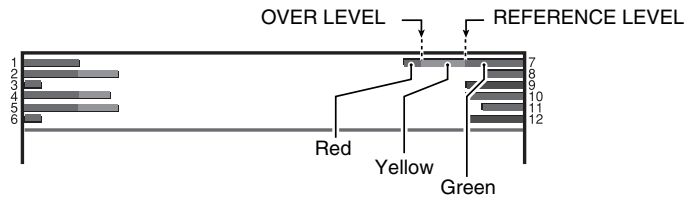

- When "BAR TYPE" is set to "W.100," the standard input level set in "REFERENCE LEVEL" is displayed with the line indication. The input level set in "OVER LEVEL" is not displayed.
- The level meter with no audio signal input is displayed in white for "3COLORS," and in gray for "W.100."
- You can select the position of the level meter display—top or bottom of the screen (Ⓜ "POSITION" in "INFORMATION" on page 15).

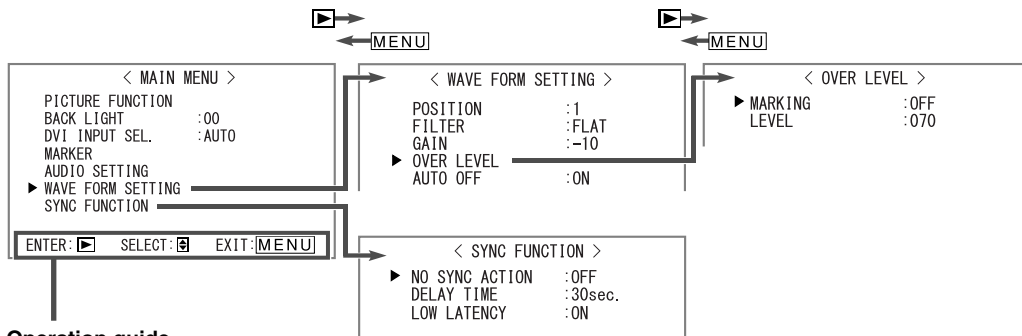

Operation guide
Shows the buttons for each operation.

WAVE FORM SETTING*1

Settings for the wave form monitor

Item	To do	Setting value
POSITION	Select the position of the wave form monitor.	1 (lower right), 2 (lower left), 3 (upper left), 4 (upper right)
FILTER	Activates/deactivates the low-pass filter for the incoming wave form data.	FLAT (no filter), LOWPASS
GAIN	Adjust the gain level for the incoming wave form data.	-10 - +10
OVER LEVEL	Select the over level for the incoming luminance signals.	☞ "NOTE"
MARKING	Activates/deactivates the function to change the color of a wave form when the signal exceeds the limit specified on "LEVEL" (☞ below).	OFF, ON
LEVEL	Adjust the lower limit for the luminance signal	070 - 109
AUTO OFF	Activates/deactivates the function to make the wave form monitor indication go off automatically 15 minutes after displaying it.	ON, OFF

*1 This function does not work for the signals as follows:

RGB input signals (digital), DVI signals (digital/inputted from personal computer), 1080/60p (analog/digital), 1080/50p (analog/digital), 640 * 480/60p (analog/digital).

SYNC FUNCTION

Settings for the synchronization with signals

Item	To do	Setting value
NO SYNC ACTION	Select the screen status when no signal is coming in.	OFF, P.SAVE (power save mode), GRAY B. (gray screen)
DELAY TIME	Select the period until the screen status changes as selected in "NO SYNC ACTION" after signals stop coming in.	30sec., 5min., 15min.
LOW LATENCY	Activates/deactivates the function to shorten the time taken to display the picture (low latency function). • If the picture is not displayed steadily while "ON" is selected, select "OFF." • While "ON" is selected, the displayed picture may become unstable when an operation using buttons on the front panel or the menu is performed, or when the signal format changes.	ON, OFF

- When setting "NO SYNC ACTION" to "GRAY B.," the screen color changes to gray and the power consumption of the back light is saved by half. Selecting "P.SAVE" (power save mode) saves more power consumption by turning off the back light.

NOTE

Example of the wave form monitor

Ex.: When "MARKING" is set to "ON" and "LEVEL" is set to "080"

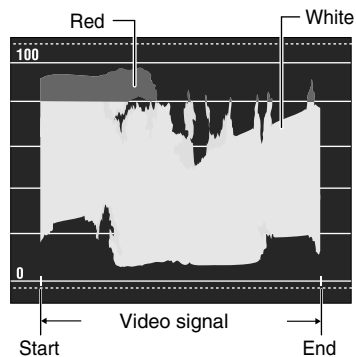

- The wave which goes over the value set on "LEVEL" is indicated in Red.

For the operation procedure, see page 7.

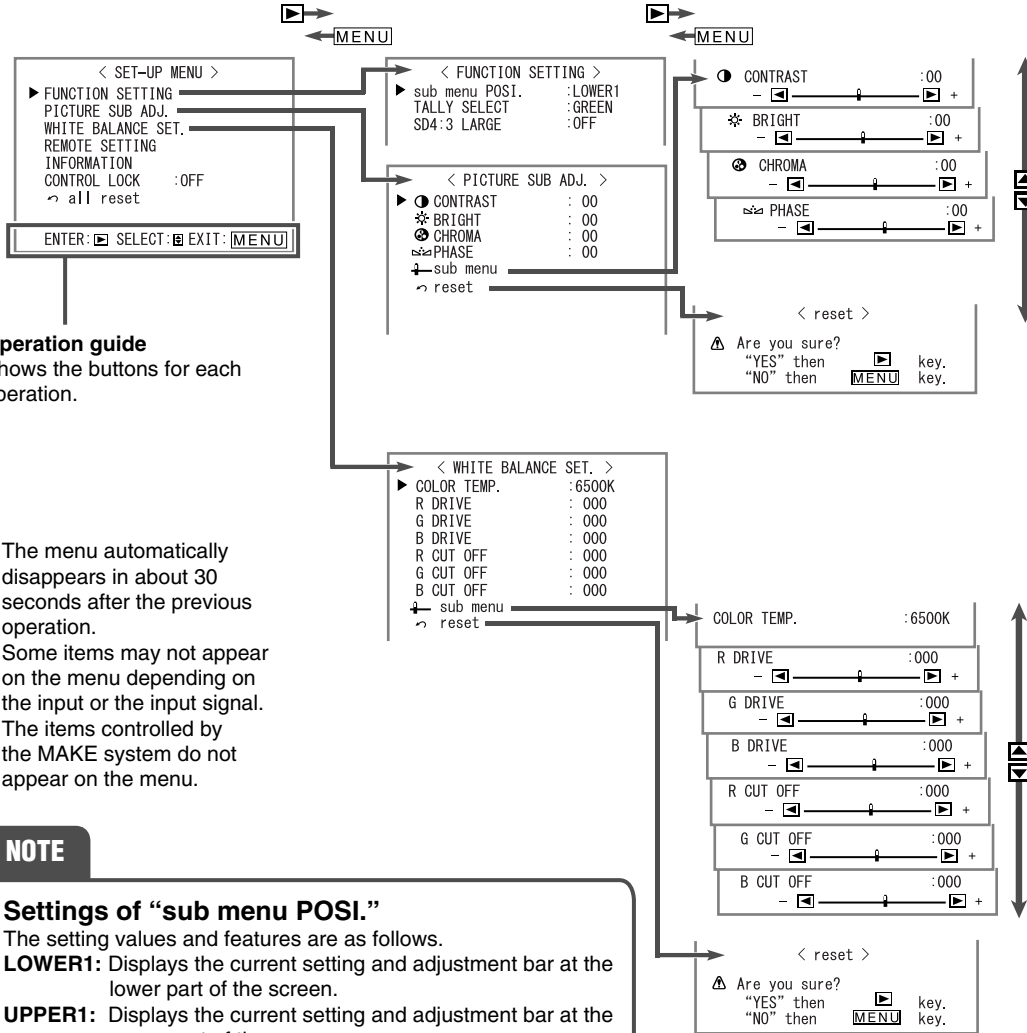

Operation guide
Shows the buttons for each operation.

- The menu automatically disappears in about 30 seconds after the previous operation.
- Some items may not appear on the menu depending on the input or the input signal.
- The items controlled by the MAKE system do not appear on the menu.

NOTE

Settings of “sub menu POSI.”

- The setting values and features are as follows.
- LOWER1:** Displays the current setting and adjustment bar at the lower part of the screen.
 - UPPER1:** Displays the current setting and adjustment bar at the upper part of the screen.
 - LOWER2:** Displays the current setting at the lower part of the screen.
 - UPPER2:** Displays the current setting at the upper part of the screen.

- The adjustment bar is not displayed for some items.

Settings of “SD4:3 LARGE”

- The setting values and features are as follows.
- OFF:** Fit the vertical picture size into the pixel numbers of the monitor display.
 - ON:** Fit the vertical picture size into that of the monitor display.

FUNCTION SETTING

Setting for the sub menu display, color of the tally lamp and the picture size.

Item	To do	Setting value
sub menu POSI.	Select the contents and displaying position of “sub menu.”	☞ “NOTE”
TALLY SELECT	Select the color of the tally lamp.	GREEN, RED
SD4:3 LARGE	Change the picture size of 4:3 format signal.	☞ “NOTE”

PICTURE SUB ADJ.

Adjusts the standard level for the picture adjustment.

Item	To do	Setting value
CONTRAST*1	Adjust the standard level for the contrast adjusted with CONTRAST knob on the front panel.	-20 – +20
BRIGHT*1	Adjust the standard level for the brightness adjusted with BRIGHT knob on the front panel.	-20 – +20
CHROMA*1	Adjust the standard level for the chroma adjusted with CHROMA knob on the front panel.	-20 – +20
PHASE*1	Adjust the standard level for the phase adjusted with PHASE knob on the front panel.	-20 – +20
sub menu	Display the sub menu which enables you to adjust the items in “PICTURE SUB ADJ.” while viewing the actual picture.	
reset	Restore the default settings for all the items in “PICTURE SUB ADJ.”	

*1 Memorized for each input.

WHITE BALANCE SET.

Selects the color temperature and adjusts the drive level and cutoff point of each color (R/G/B).

Item	To do	Setting value
COLOR TEMP.	Select the color temperature.	9300K, 6500K, USER
R DRIVE, G DRIVE, B DRIVE*2	Adjust the drive level of each color (red, green, and blue).	MIN – 000 – MAX (in 256 grades)
R CUT OFF, G CUT OFF, B CUT OFF*2	Adjust the cutoff point of each color (red, green, and blue).	MIN – 000 – MAX (in 256 grades)
sub menu	Display the sub menu which enables you to adjust the items in “WHITE BALANCE SET.” while viewing the actual picture.	
reset	Restore the default settings for the drive levels and cutoff points of the selected color temperature.	

*2 Memorized for each color temperature.

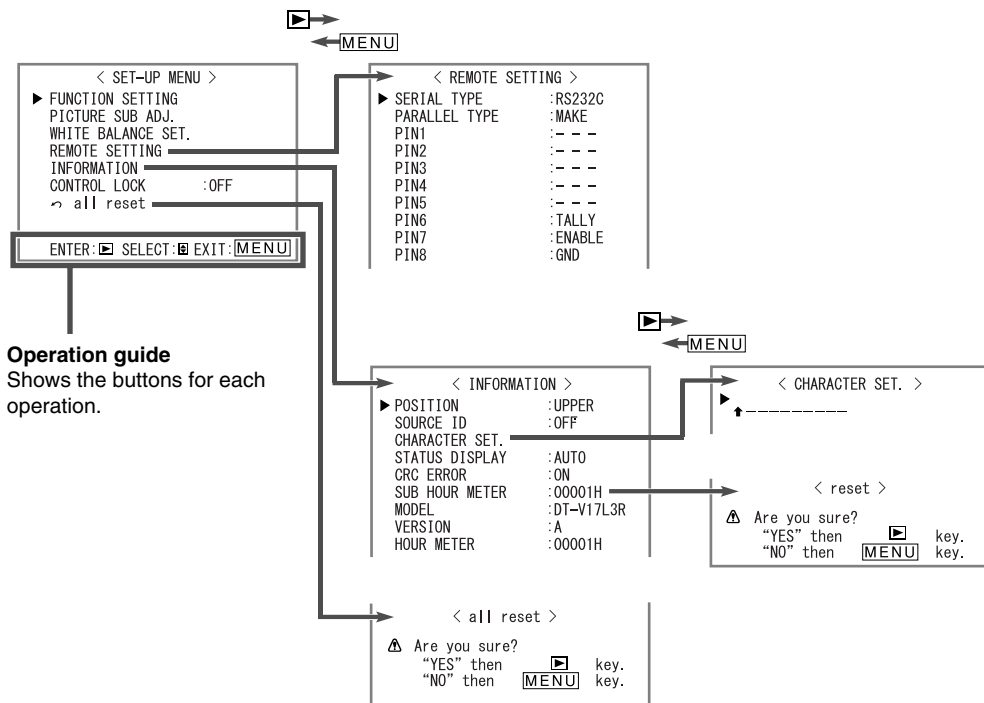

Operation guide
Shows the buttons for each operation.

- The menu automatically disappears in about 30 seconds after the previous operation.
- Some items may not appear on the menu depending on the input or the input signal.
- The items controlled by the MAKE system do not appear on the menu.

NOTE

Setting of "CHARACTER SET."

Assign a name for each video source.

- 1 Change the input to one that you want to assign a video source name for.
- 2 Select "CHARACTER SET."
- 3 Press Δ / ∇ buttons to select the first character.
 - Each time you press Δ button, the character changes as follows. Press ∇ button to reverse the order.

Space → 0 - 9 → A - Z → a - z → &()*+,-./:<>_
- 4 Press \triangleright button to move the arrow to the next space.
 - The characters entered before moving the arrow are memorized.
- 5 Repeat steps 3 and 4 (10 characters at maximum).
- 6 Press MENU button to store the name.

REMOTE SETTING (External Control on pages 16 to 18)

Settings for the external control

Item	To do	Setting value
SERIAL TYPE	Select the input terminal used for external control by serial communication.	RS232C, RS485
PARALLEL TYPE	Select the external control method for the MAKE/TRIGGER terminal.	MAKE, TRIGGER, SET
PIN1, PIN2, PIN3, PIN4, PIN5	Assign the control functions to the pins of the MAKE/TRIGGER terminal. <ul style="list-style-type: none"> • Assign a function to each pin terminal by selecting "SET" in "PARALLEL TYPE" mentioned above. (The functions are assigned for "PIN6" – "PIN8" and you cannot change the assignment of these functions.) 	Functions controlled by the MAKE/TRIGGER system" on page 17

INFORMATION

Settings for the information display of the monitor

Item	To do	Setting value
POSITION	Select the position to show the information display (External Control "On the Information Display" on page 7).	UPPER, LOWER
SOURCE ID	Select if the name assigned in "CHARACTER SET." is displayed on the screen (External Control "On the Information Display" on page 7).	OFF, ON
CHARACTER SET.*1	Assign a name to each video source as you like (10 characters at maximum). You can also enter a name using the RS-232C system.	External Control "NOTE"
STATUS DISPLAY	Select if the status of the current input is displayed on the screen (External Control "On the Status Display" on page 7).	AUTO, OFF, ON
CRC ERROR	Select if the CRC error indication for the input HD SDI signal is displayed on the screen (External Control "On the Information Display" on page 7).	ON, OFF
SUB HOUR METER	Display the hours of use (unit: hour). You can reset this item.	
MODEL	Display the model name of the monitor.	
VERSION	Display the version of the monitor.	
HOUR METER	Display the total hours of use (unit: hour). This item is used for maintenance of the monitor. You cannot reset this item.	

*1 Memorized for each input.

CONTROL LOCK Setting value: OFF, ON

Turns on (or off) the control lock function to disable the buttons on the front panel.

- The following operations are available even when this function is activated.
 - Turning on/off (on standby) the monitor
 - Displaying the SET-UP MENU (by pressing \triangleleft button while holding ∇ button) and turning "CONTROL LOCK" to "OFF"
 - Operating the monitor by an external control
- If you try other operations, "Control lock on!" appears on the screen.

all reset

Restores all the settings and adjustments of the monitor to the default.

- "HOUR METER" and the settings done by using the adjustment knobs on the front panel will not be reset.
- The monitor is turned off (on standby) then turned on automatically.

■ About the external control

This monitor has three external control terminals.

- **MAKE/TRIGGER terminal** (RJ-45): The following external control systems are available.
 - (1) **MAKE (make contact) system**: Controls the monitor by short-circuiting the corresponding pin terminal to the GND pin terminal, or disconnecting (opening) it.
 - (2) **TRIGGER (trigger) system**: Controls the monitor by sending the pulse signal instantaneously to the corresponding pin terminal.
- ☞ “Using the MAKE/TRIGGER system” on page 17
- **RS-485 terminals** (RJ-45): Controls the monitor with the RS-485 system. (☞ “Using the serial communication” on page 18)
- **RS-232C terminal** (D-sub 9-pin): Controls the monitor with the RS-232C system. (☞ “Using the serial communication” on page 18)

Set the following items of “REMOTE SETTING” in SET-UP MENU according to the external control terminal and control system (☞ “SERIAL TYPE”, “PARALLEL TYPE” on page 15).

Control terminal	Control system	The settings of this unit	
		“SERIAL TYPE” setting	“PARALLEL TYPE” setting
MAKE/TRIGGER terminal	MAKE	—	MAKE
	TRIGGER	—	TRIGGER
RS-485 terminal	Serial communication	RS-485	RS485*1
RS-232C terminal		RS-232C	RS232C*1

*1 For a monitor connected to a personal computer etc, select the terminal the equipment is actually connected to. For other monitors, select “RS485.”

Control priority is as follows.

MAKE > TRIGGER = serial communication = buttons and menu on the monitor

- You can use the external control even when “CONTROL LOCK” is set to “ON” (☞ page 15).
- When the monitor is off (on standby), external control is not available. But certain external controls (starting/terminating communication, turning on the monitor) are available through the serial communication (☞ page 18).

<MAKE/TRIGGER system>

You can control the monitor by a personal computer or dedicated controller*2.

- For the details, see page 17.

*2 The controller is not commercially available. Consult your dealer if you need it.

<Serial communication>

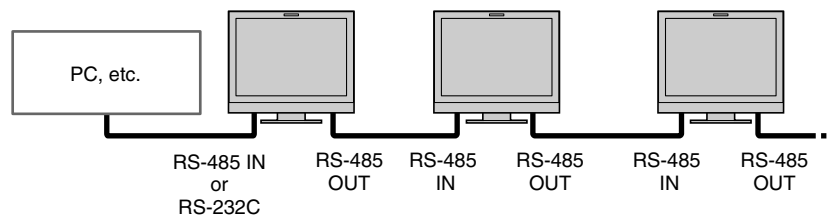

- For the details, see page 18.

■ Using the MAKE/TRIGGER system

The MAKE/TRIGGER terminal is configured as follows. You can assign a function to each pin terminal in "REMOTE SETTING" (☞ "PIN1, PIN2, PIN3, PIN4, PIN5" in "PARALLEL TYPE" on page 15).

- You cannot change the functions assigned to the pin terminals from 6th to 8th.

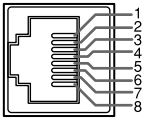

This is a female terminal.

Pin No.	Pin name
1	PIN1
2	PIN2
3	PIN3
4	PIN4
5	PIN5
6	PIN6 (TALLY)* ¹
7	PIN7 (ENABLE)* ²
8	PIN8 (GND)

*¹ The 6th pin terminal controls turning on or off the tally lamp (available to control even when the 7th pin terminal is invalid).

*² The 7th pin terminal makes the external control valid/invalid. Make sure to control the terminal by the MAKE system.

To assign the functions to the pin terminals

For the operation procedure, see page 7.

- 1 Select "REMOTE SETTING" on the SET-UP MENU.
- 2 Set "PARALLEL TYPE" to "SET."
- 3 Select a pin name ("PIN1" – "PIN5") for which you want to assign a function, then select the function you want to assign.
 - For selectable functions, see the tables on the right.

Operation of the external control

- 1 Set "PARALLEL TYPE" of "REMOTE SETTING" to "MAKE" or "TRIGGER" in the SET-UP MENU.
 - 2 Short-circuit the 7th pin terminal (ENABLE) to the 8th pin terminal (GND) so that the monitor can be controlled by the external control.
 - 3 When the "MAKE" system is selected: Operate each function by short-circuiting the corresponding pin terminal to the 8th pin terminal (GND) or opening it.
When the "TRIGGER" system is selected: Operate each function by pulse control, that is short-circuiting the corresponding pin terminal to the 8th pin terminal (GND) for about 1 second and opening it.
- When changing the input with MAKE system, only one pin terminal must be short-circuited. (Other pin terminals must be opened.)
 - When selecting the "TRIGGER" system, you can operate only one function at a time. Operate the functions one by one.

<Functions controlled by the MAKE/TRIGGER system>

Display	Functions to be controlled	Opening	Short-circuiting
TALLY SEL	Selects the color of the tally lamp.	Green	Red
SDI 1	Changes the input to "SDI 1."	Invalid	Valid
SDI 2	Changes the input to "SDI 2."	Invalid	Valid
DVI	Changes the input to "DVI."	Invalid	Valid
A.MARKER	The area marker indication	Off	On
S.MARKER	The safety marker indication	Off	On
FRAME	Indication of the area of the specified aspect ratio	Off	On
C.MARKER	The center marker indication	Off	On
MARK.SEL	Selects the items of "MARKER"* ³	Non-"R-" items	"R-" items
ASPECT	Changes the aspect ratio.	4:3	16:9
1:1	Displays in 1:1 mode.	Off	On
STATUS	Status display* ⁴	☞ "On the Status Display" on page 7	
L.METER	Audio level meter display	* ⁵	
TIME CODE	Time code display	Off	On
SOURCE ID	☞ "SOURCE ID" in "INFORMATION" on page 15	Off	On
WAVE FORM	Wave form monitor display	* ⁶	
COLOR OFF	Color off	Color	Monochrome
SCR CHECK	Screens check	* ⁷	
I/P MODE	Change a mode according to a input picture.	* ⁸	
---	No function	—	—

*³ Selects which functions in "MARKER" are activated, non-"R-" items or "R-" items (☞ "MARKER" on page 11).

*⁴ Displays the information shown when INPUT SELECT button of the current input is pressed (☞ "On the Status Display" on page 7). While controlling with the MAKE system, the information is displayed only at the moment of short-circuiting.

*⁵ While controlling with the MAKE system, the level meter is switched between displayed (short-circuiting) and hidden (opening). When "LEVEL METER ch" is set to "OFF," the level meter is not displayed ("NO EFFECT" appears). While controlling with the TRIGGER system, the pattern of the audio channel display is switched.

*⁶ Must be controlled with the TRIGGER system. Controls whether displaying/hiding the wave form monitor (This function cannot be controlled with the MAKE system.).

*⁷ While controlling with the MAKE system, the screen is switched between normal screen (opening) and blue screen (short-circuiting). While controlling with the TRIGGER system, the screen changes as same as when pressing SCREENS CHECK button (☞ [8] on page 6).

*⁸ Must be controlled with the TRIGGER system. The mode changes in the order of "NORMAL" ⇒ "CINEMA" ⇒ "FIELD". (This function cannot be controlled with the MAKE system.)

- You cannot assign the same function to different pin terminals.
- The TRIGGER system switches each function by short-circuiting the pin terminal for about 1 second and opening it.

Using the serial communication

You can control the monitor from a personal computer etc. via the RS-485 or RS-232C terminal.

- Consult your dealer for the details of the external control specification.

<Communication specifications>

Input terminal	Cable	Terminal specification	Communication specifications
RS-485	A straight LAN cable	☞ See below	Baud Rate: 4800 bps Data Bits: 8 bits Parity: No parity Stop Bits: 1 bit Flow Control: No control Communication Code: ASCII Code
RS-232C	A straight cable with a D-sub 9-pin connector (male for the monitor, female for the personal computer etc.)		

<Specifications of the RS-485 terminal>

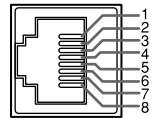

This is a female terminal.

Pin No.	IN terminal signal	OUT terminal signal
1	TXD +	TXD +
2	TXD -	TXD -
3	RXD +	RXD +
4	NC	NC
5	NC	NC
6	RXD -	RXD -
7	NC	NC
8	GND	GND

<Specifications of the RS-232C terminal>

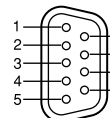

This is a female terminal.

Pin No.	Signal
1	NC
2	RXD
3	TXD
4	NC
5	GND
6	NC
7	RTS
8	CTS
9	NC

- The 7th terminal and the 8th terminal are connected.

<Command outline>

All commands consist of the following segments.

Header	Monitor ID	Command ID	Function	Data	Cr (0DH)
--------	------------	------------	----------	------	----------

On Header

"!": Operation commands from the personal computer, etc. For details, see <Basic command list> on the right.

"?": Reference commands from the personal computer, etc.

"@": Status returns from the monitor

- To start communication, send the connection command from the personal computer etc.
- To terminate the communication, send the termination command from the personal computer etc.

Example of communication procedures

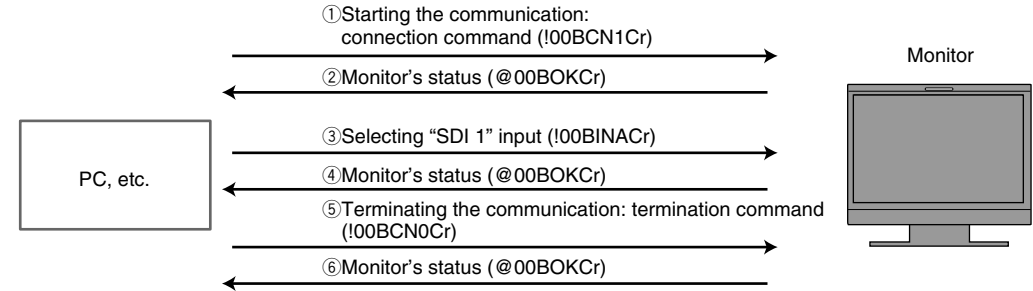

<Basic command list>

No.	Commands	Functions	Data
1	! * **1 B C N 1 Cr	Starts communication (connection)	No data
2	! * **1 B C N 0 Cr	Terminates communication (termination)	No data
3	! * **1 B I D S E T x x*2 Cr	Assigns the control ID	01 - 99, A0 - A9, B0 - B9, C0 - C7*3
4	! * **1 B I D R E T Cr	Initializes the control ID	No data
5	! * **1 B I D D S P x x*2 Cr	Displays/hides the ID	00: Hide 01: Display
6	! * **1 B I D C H K x x*2 Cr	Flashes/hides the selected ID No. of the monitor	00: Hide 01: Display
7	! * **1 B M E N U Cr	Displays the MAIN MENU/Quits the menu operation	No data
8	! * **1 B U P Cr	Moves the cursor upward (Δ)	No data
9	! * **1 B D O W N Cr	Moves the cursor downward (∇)	No data
10	! * **1 B A D J R Cr	Makes setting/adjustment (▷)	No data
11	! * **1 B A D J L Cr	Makes setting/adjustment (◁)	No data
12	! * **1 B S E T U P Cr	Displays the SET-UP MENU	No data
13	! * **1 B P W 1 Cr	Turns on the monitor	No data
14	! * **1 B P W 0 Cr	Turns off the monitor (on standby)	No data
15	! * **1 B I N A Cr	Selects "SDI 1" input	No data
16	! * **1 B I N B Cr	Selects "SDI 2" input	No data
17	! * **1 B I N C Cr	Selects "DVI" input	No data
18	! * **1 B D I S P Cr	Displays the status*4	No data
19	! * **1 B A S P x x*2 Cr	Changes the aspect ratio	00: 4:3, 01: 16:9

- "Cr" is 0Dh.
- The commands for starting communication (connection) (No. 1), terminating communication (termination) (No. 2), and turning on the monitor (No. 13) can be used while the monitor is off (on standby).

*1 " **" is the control ID assigned by the command of No.3. The initial setting of the ID is "00." When connecting several monitors, "00" is a command for controlling all monitors at once.

*2 Enter the appropriate data to "xx."

*3 Up to 127 IDs can be assigned. To assign a 3-digit ID (100 to 127), enter a hexadecimal number for the first 2 digits; "A" for "10," "B" for "11," and "C" for "12." To assign ID "115," for example, enter "B5."

*4 Displays the information shown when the INPUT SELECT button currently lit is pressed (☞ "On the Status Display" on page 7).

Troubleshooting

Solutions to common problems related to the monitor are described here. If none of the solutions presented here solve the problem, unplug the monitor and consult an authorized dealer or service center.

Symptom	Probable cause and corrective action	Page
No power supply	• Press the  button.	6
	• Turn on the POWER switch on the rear panel.	8
	• Firmly insert the AC power plug.	8
No picture with the power on	• Select the correct input using the INPUT SELECT buttons.	6
	• Connect the signal cable firmly.	8
	• Turn on the power of the connected component and set the output correctly.	—
	• Check whether the input signal format is acceptable on the monitor.	9
“OTHERS” or “Out of range” appears.	• Check whether the input signal format is acceptable on the monitor.	7, 9
“NO SYNC” appears.	• Select the correct input using the INPUT SELECT buttons.	6
	• Connect the signal cable firmly.	8
	• Turn on the power of the connected component and output video signals. Or, check whether the video output of the component (video output setting of the VCR or graphic board of the computer) is set correctly.	—
Wrong color, no color	• Adjust each picture adjustment knob on the front panel or adjust the items of “PICTURE SUB ADJ.” in the SET-UP MENU. Or, perform “reset” in “PICTURE SUB ADJ.”	6, 14
	• Check whether the setting of COLOR OFF or SCREENS CHECK buttons are appropriate.	6
	• Adjust the items of “WHITE BALANCE SET.” in the SET-UP MENU. Or, perform “reset” in “WHITE BALANCE SET.”	14

Symptom	Probable cause and corrective action	Page
The picture becomes blurred.	• Adjust the picture contrast or brightness by using the adjustment knobs on the front panel. Or, adjust “CONTRAST” or “BRIGHT” of “PICTURE SUB ADJ.” in the SET-UP MENU.	6, 14
Wrong picture position, wrong picture size.	• Check whether the setting of 1:1 or ASPECT buttons is appropriate.	6
	• Check whether the input signal format is acceptable on the monitor.	9
	• For some signals, the picture cannot be displayed fully in the effective screen area. There is no sure method to solve this problem.	—
Some items do not appear on the menu.	• The items which are not available for the current input or the current input signal are not displayed on the menu. Change the input or the input signal.	—
	• The items controlled by the MAKE system do not appear on the menu.	17
Buttons on the monitor do not work.	• Set “CONTROL LOCK” in the SET-UP MENU to “OFF.”	15
	• You cannot use the buttons for the items controlled by the MAKE system. Disable the external control.	16, 17

The following are not malfunctions.

- When a still image is displayed for a long time, it may remain indistinctly on the screen after the picture has changed. Though the remaining picture will disappear after a while, there may be a case that it remains for a long period depending on the length of time the still image was displayed for. This is due to the characteristics of the LCD display and is not a malfunction.
- Red spots, blue spots and green spots on the panel surface are a normal characteristic of LCD displays, and not a problem. The LCD display is built with very high precision technology; however, be aware that a few pixels may be missing or constantly lit.
- The following symptoms are problems only when pictures are not played back normally.
 - A slight electric shock occurs when you touch the monitor.
 - The top and/or rear panel of the monitor becomes hot.
 - The monitor emits a cracking noise.
 - The monitor emits a mechanical noise.

■ Self-check program

This monitor has a self-check function, which allows it to detect malfunctions and alert you. This makes troubleshooting easier. Whenever a problem occurs, one or some of the self-check lamps will flash. If this happens, follow the steps below and contact your dealer to resolve the problem.

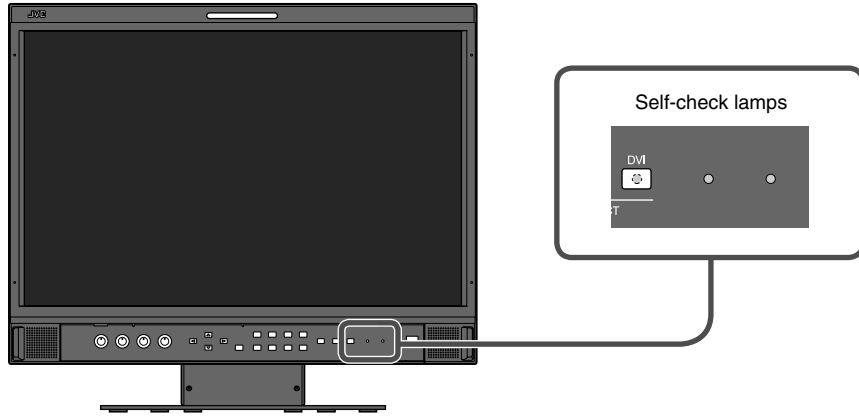

When the screen goes blank, and one or some of the self-check lamps on the front control panel start flashing...

1 Check which lamps are flashing.

2 Press  /  button to turn off (on standby) the monitor.

3 Turn off the POWER switch on the rear panel.

4 Disconnect the AC power cord from the AC outlet.

5 Contact your dealer with the information about which lamps were flashing.

- If you turn on the monitor soon after turning it off (or after a short-term power failure), the self-check lamps may flash and no image may be displayed.

When this happens, turn off power and wait at least 10 seconds before turning on the monitor again.

If the self-check lamps do not flash, you can use the monitor as normal.

Unplug this product from the wall outlet before cleaning.

Screen

To avoid irreparable change in appearance of the screen such as uneven color, discoloration, scratches, be careful about the following:

- Do not paste or stick anything using any glues or adhesive tapes.
- Do not write anything on the screen.
- Do not strike the screen with a hard object.
- Avoid condensation on the screen.
- Do not wipe the screen with solvent such as alcohol, thinner, or benzene.
- Do not wipe the screen forcefully.

Wipe stains off the screen with a soft cloth. If the screen gets heavily stained, wipe it with a soft cloth soaked in water-diluted neutral detergent and wrung well, then wipe with a soft dry cloth.

Cabinet

To avoid the deterioration or damages of the cabinet such as its paint's peeling away, be careful about the following:

- Do not wipe the cabinet using solvent such as alcohol, thinner, or benzene.
- Do not expose the cabinet to any volatile substance such as insecticides.
- Do not allow any rubber or plastic in contact for a long time.
- Do not wipe the cabinet forcefully.

Wipe stains off the cabinet with a soft cloth. If the cabinet gets heavily stained, wipe it with a soft cloth soaked in water-diluted neutral detergent and wrung well, then wipe with a soft dry cloth.

Ventilation openings

Use a vacuum cleaner to get rid of the dust around the intakes (all the openings). If a vacuum cleaner is not available, use a cloth and wipe it off. Leaving the dust around the intakes may prevent proper temperature control and cause damage to the product.

Specifications

■ General

Model name	DT-V17L3R
Type	Multi format LCD monitor
Screen size	Type 17 wide format
Aspect ratio	16:10
LCD panel	17" wide, active matrix TFT
Effective screen size	Width: 367.2 mm (14 7/16") Height: 229.5 mm (9")
Number of pixels displayed	1 440 x 900
Number of colors displayed	16.77 million
Viewing angle (TYP.)	160° (Horizontally), 140° (Vertically)
Panel brightness (TYP.)	400 cd/m ²
Contrast ratio (TYP.)	600:1
Horizontal/vertical frequency (computer signal)	H: 31.469 kHz – 75.000 kHz V: 48 Hz – 65 Hz * Some signals within this frequency range may not be displayed ("Out of range" is displayed).
Compliant video signal format	☞ "Available signals" on page 9
Format	HD SDI: BTA S-004B, SMPTE292M SD SDI: ITU-R BT.656: 525/625 SMPTE259M: 525 EMBEDDED AUDIO: SMPTE299M, SMPTE272M
Operating conditions	Operating temperature: 5°C – 35°C (41°F – 95°F) Operating humidity: 20% – 80% (non-condensing) (Slightly variable depending on ambient conditions for installation.)
Power requirements	AC 120 V/AC 220 – 240 V, 50 Hz/60 Hz
Rated current	0.56 A (AC 120 V)/0.36 A (AC 220 – 240 V)
External dimensions (excluding protruding parts)	Width: 395 mm (15 5/8") (with the stand), 395 mm (15 5/8") (without the stand) Height: 344.8 mm (13 5/8") (with the stand), 304 mm (12") (without the stand) Depth: 199 mm (7 7/8") (with the stand), 86 mm (3 1/2") (without the stand)
Weight	6.8 kg (15.0 lbs) (with the stand) 5.1 kg (11.2 lbs) (without the stand)
Accessories	AC power cord, Power cord holder x 1, Screw x 2 (for power cord holder)

Notice on transportation

This monitor is precision equipment and needs dedicated packing material for transportation. Never use any packing material supplied from sources other than JVC or JVC-authorized dealers.

■ Input/output terminals

Video	DVI-D (HDCP)	DVI-D signal input (compatible with HDCP): DVI-D connector x 1 (compatible with DDC2B)
	E. AUDIO HD/SD SDI (IN 1)	Digital signal input (compatible with EMBEDDED AUDIO signals): auto detection, 1 line, BNC connector x 1
	E. AUDIO HD/SD SDI (IN 2)	
External control	E. AUDIO HD/SD SDI (SWITCHED OUT)	Digital signal output (compatible with EMBEDDED AUDIO signals): 1 line switched out, BNC connector x 1
	REMOTE (MAKE/TRIGGER)	☞ "Using the MAKE/TRIGGER system" on page 17
	REMOTE (RS-485)	☞ "Using the serial communication" on page 18
REMOTE (RS-232C)		

- For easy understanding, pictures and illustrations are shown by being emphasized, omitted or composed, and may be slightly different from actual products.
- Design and specifications are subject to change without notice.
- All company names and product names mentioned herein are used for identification purposes only, and may be the trademarks or registered trademarks of their respective companies.



■ Dimensions Unit: mm (inch)

<Front view>

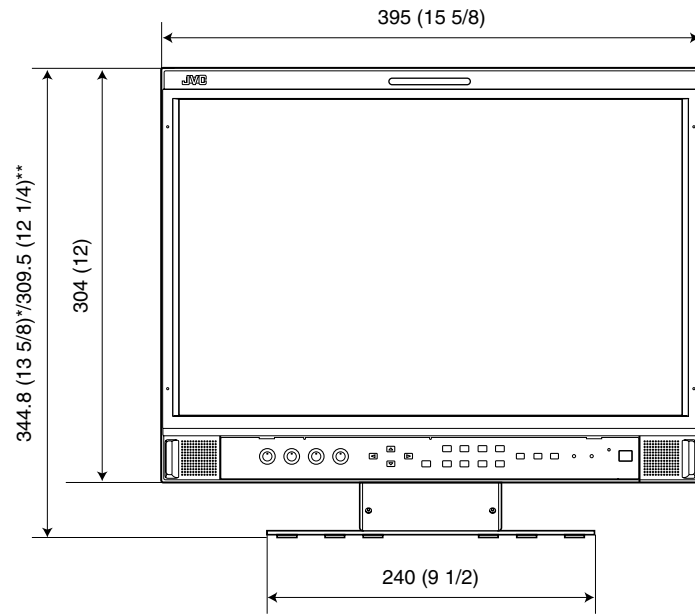

* at the higher position
** at the lower position

<Side view>

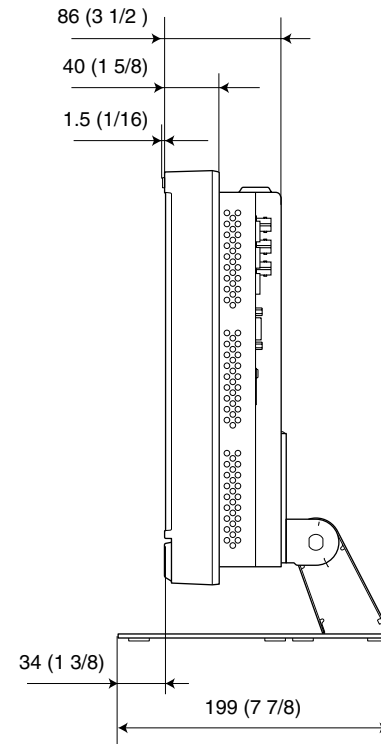

<Rear view>

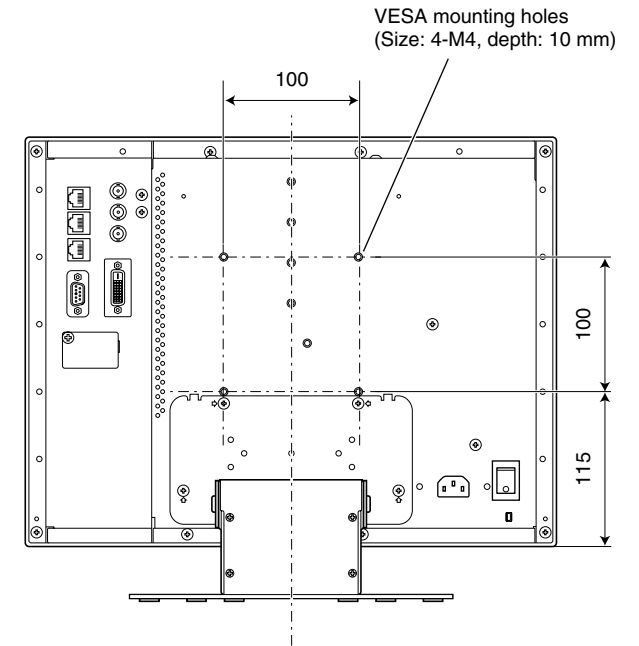

JVC