

WIRELESS SOLUTION MADE IN SWEDEN



W-DMX G4 MK I and MK II USER MANUAL

BlackBox and WhiteBox F-1
BlackBox and WhiteBox R-512
BlackBox and WhiteBox F-2
Micro F-1 Lite
Micro R-512 Lite
ProBox F-2500



W-DMX G4(S) User Manual

Issue date: 2014-03

Edition: 3

Subject to modifications.

All trademarks referenced are trademarks or registered trademarks of their respective owners, whose protected rights are acknowledged.

Copyright Wireless Solution Sweden Sales AB

Wireless Solution Sweden Sales AB
Stureparksvägen 7
451 55 Uddevalla
Sweden
Tel.: +46 522 511 511
Fax: +46 522 440 885
E-Mail: helpdesk@wirelessdmx.com
Web: www.wirelessdmx.com

Contents

1	Your Wireless DMX G4 system (W-DMX G4S)	7
2	The W-DMX technology	8
3	About this document	10
3.1	Target group of this document	10
3.2	Signs and symbols in this document.....	10
4	BlackBox and WhiteBox F-1	11
4.1	Scope of delivery.....	11
4.1.1	BlackBox F-1	11
4.1.2	WhiteBox F-1.....	11
4.2	Connectors and ports.....	12
4.2.1	BlackBox F-1	12
4.2.2	WhiteBox F-1 MK I	13
4.2.3	WhiteBox F-1 MK II	14
4.3	LEDs	15
4.4	Installing the unit	16
4.4.1	BlackBox F-1	16
4.4.2	WhiteBox F-1.....	17
4.5	Switching FLEX modes.....	19
4.6	Operation as a transmitter.....	20
4.6.1	Prerequisites for successful linking with receivers.....	20
4.6.2	Linking receivers.....	21
4.6.3	Unlinking all receivers.....	22
4.7	Operation as a receiver.....	22
4.7.1	Linking with transmitters	22
4.7.2	Unlinking from transmitters	23
4.8	Switching CTRL modes.....	23
5	BlackBox and WhiteBox R-512	25
5.1	Scope of delivery.....	25
5.1.1	BlackBox R-512.....	25
5.1.2	WhiteBox R-512	25
5.2	Connectors and ports.....	25
5.2.1	BlackBox R-512.....	25

Contents

5.2.2	WhiteBox R-512	26
5.3	LEDs	26
5.4	Installing the unit	26
5.5	Operation as a receiver	26
6	BlackBox and WhiteBox F-2	27
6.1	Scope of delivery	27
6.1.1	BlackBox F-2	27
6.1.2	WhiteBox F-2	27
6.2	Connectors and ports	27
6.2.1	BlackBox F-2	27
6.2.2	WhiteBox F-2 MK I	29
6.2.3	WhiteBox F-2 MK II	30
6.3	LEDs	31
6.4	Installing the unit	32
6.5	Switching FLEX modes	32
6.6	Operation as a transmitter	33
6.7	Operation as a receiver	33
6.8	Operation as a repeater	33
6.9	Switching CTRL modes	34
7	Micro units	35
7.1	Micro F-1 Lite	35
7.1.1	Scope of delivery	35
7.1.2	Connectors and ports	35
7.1.3	LEDs	35
7.1.4	Installing the unit	36
7.1.5	Switching FLEX modes	36
7.1.6	Operation as a transmitter	36
7.1.7	Operation as a receiver	36
7.1.8	Switching CTRL modes	36
7.1.9	Battery option	37
7.2	Micro R-512 Lite	38
7.2.1	Scope of delivery	38
7.2.2	Connectors and ports	38
7.2.3	LEDs	39



7.2.4	Installing the unit.....	39
7.2.5	Operation as a receiver	39
8	ProBox F-2500.....	40
8.1	Scope of delivery.....	40
8.2	Connectors and ports.....	40
8.3	LEDs	41
8.4	Installing the unit	41
8.5	Switching FLEX modes	41
8.6	Operation as a transmitter.....	41
8.7	Operation as a receiver.....	42
8.8	Operation as a repeater	42
8.9	Switching CTRL modes.....	42
9	Technical data.....	43
9.1	BlackBoxes (BB) and WhiteBoxes (WB) F-1, R-512 and F-2.....	43
9.2	MicroBox F-1 Lite and MicroBox R-512 Lite	45
9.3	ProBox F-2500	47
10	FAQ – Frequently asked questions	49
11	Appendix:Certificates.....	52
11.1	E1551 RFC	52
11.2	ETSI Test Report	53
11.3	GRANT OF EQUIPMENT AUTHORIZATION	55



1 Your Wireless DMX G4 system (W-DMX G4S)

Thank you for purchasing the Wireless DMX G4 system (W-DMX G4), the industry's leading system for transmitting and receiving DMX signals reliably.

There are one or two operating modes for W-DMX G4 units, depending on which unit you have purchased:

- W-DMX G4 Receivers to receive W-DMX signals (denoted with an R in their product model name)
- W-DMX G4 Transceiver to receive, transmit or repeat W-DMX signals (denoted with an F in their product model name)

W-DMX G4 Transceivers (or 'Flex' model units) can be changed between Transmit Mode and Receive Mode with the procedure described in chapter 4.5 Switching FLEX modes", page 19.

W-DMX units are available in four different series:

- BlackBox MK I / MK II
- WhiteBox MK I / MK II
- MicroBox
- ProBox

The unit you have purchased is marked on the outside of the unit's packaging.

2 The W-DMX technology

2 The W-DMX technology

W-DMX technology is the core of all our products. W-DMX is specifically engineered by Wireless Solution Sweden AB to provide the same quality, reliability and performance as in any hardwired DMX data link.

W-DMX gives you even greater freedom to create reliable point-to-point, point-to-multipoint and even multipoint-to-multipoint installations over large distances and in any environment.

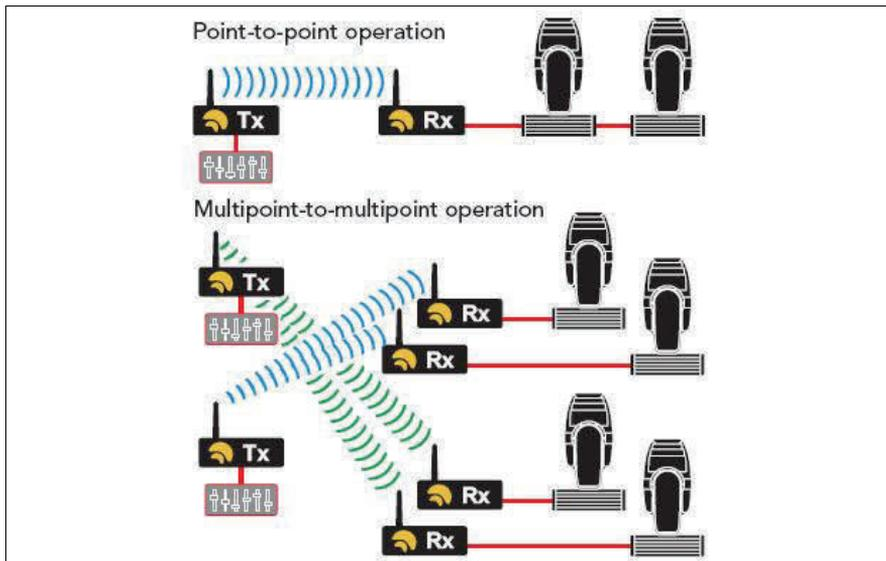

Fig. 1: Point-to-point operation versus multipoint-to-multipoint operation

W-DMX is unique in its use of advanced radio technologies that are also used in mobile phones and military communication.

Rather than using fixed frequency channels, W-DMX uses Adaptive Frequency Hopping technology to continually check the radio channels for interferences and to rapidly move operation to clear radio channels.

The checks are carried out in combination with another advanced technology: time division multiple access. This technology makes the most efficient use of every visited frequency channel.

W-DMX has the following advantages:

- Consistent and wide-ranging control of lighting systems over long distances.
- The complex communication protocols are fully automated and concealed from view - you just plug-and-play, the W-DMX G4 units do all the hard work.
- From the DMX connector of one W-DMX G4S unit to the DMX connector of another, the W-DMX system is totally transparent.

The W-DMX G4 system includes additional features that help to enhance reliability: both in its installation in any type of environment as well as in its stable operation.

W-DMX meets the USITT DMX512 and DMX512-A standards. Furthermore, W-DMX G4 units support Art-Net (I/II/III), Streaming ACN and RDM protocols (Ethernet and RDM functionality depends on model used). For this reason, the W-DMX G4 units continually are awarded the first prize for distance covered, resilience against interference and easy installation.

For additional information about our technology, please visit our website at www.wirelessdmx.com.

3 About this document

3 About this document

3.1 Target group of this document

This document is designed for lighting designers, lighting operations managers and lighting engineers.

W-DMX is an easy-to-use plug-and-play system. Basic knowledge of lighting technologies is an advantage. Every user has to be familiar with **local regulations regarding frequencies** and their usage.

For advanced settings and projects, contact your distributor.

3.2 Signs and symbols in this document

Sign / symbol	Description
 Danger	Indicates notes that, if not observed, will inevitably lead to severe injuries or death.
 Warning	Indicates notes that, if not observed, can lead to severe injuries or death.
 Caution	Indicates notes that, if not observed, can lead to light injuries.
 Caution	Indicates notes that, if not observed, can lead to damages to property.
 Hint	Indicates useful information designed to make working with the unit easier.
✓	Indicates a requirement that must be met before you can complete the corresponding tasks.
1. 2.	Indicates tasks you have to complete. The tasks must be completed in the specified order.
→	Indicates the result of a task or a series of tasks.



4 BlackBox and WhiteBox F-1

BlackBox and WhiteBox are functionally identical. The BlackBox is intended for indoor usage, the WhiteBox for outdoor usage.

4.1 Scope of delivery

4.1.1 BlackBox F-1

- 1 x BlackBox F-1 device
- 1 x user manual
- 1 x antenna adapter
- 1 x antenna indoor (2 dBi)
- 2 x mounting bracket
- 1 x Phoenix gold connector
- 1 x power cable without plug (MK I)

4.1.2 WhiteBox F-1

- 1 x WhiteBox F-1 device
- 1 x user manual
- 1 x outdoor antenna (2 dBi)
- 1 x Phoenix gold connector

No.	Port	Description
8	DC power input	Input for Phoenix gold connector: <ul style="list-style-type: none"> • Left: Ground • Right: $U_{DC} = +12\text{ V}$
9	DMX OUT bypass	XLR female 3 pin (BlackBox MK II only)
10	DMX IN for Universe 1	XLR male 3 pin output for Universe 1 (BlackBox MK II only)

4.2.2 WhiteBox F-1 MK I

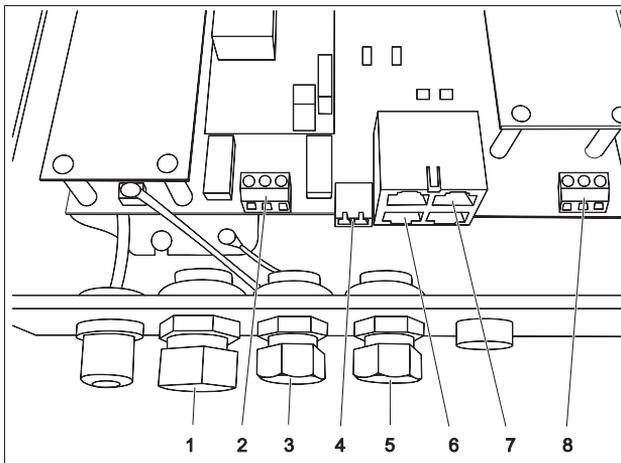

Fig. 3: Connectors and ports of the WhiteBox F-1 MK I

To ensure safe transmission of signals for outdoor use, the WhiteBox does not have XLR connectors. For this reason the connection of DMX signal cables differs slightly from the BlackBox models, which are for indoor use only.

To install the unit it is necessary to open the housing. See chapter "4.4.2 WhiteBox F-1", page 17.

No.	Port	Description
1	Cord Strip	For AC power input (2)
2	AC power input	$U_{AC} = 90\text{--}250\text{ V} / 50\text{--}440\text{ Hz}$: <ul style="list-style-type: none"> • Left: Outer conductor (L) • Middle: Ground (GND) • Right: Neutral conductor (N)
3	Cord Strip	For DC power input (4)

4 BlackBox and WhiteBox F-1

No.	Port	Description								
4	DC power input	Phoenix gold connector 12 V DC: <ul style="list-style-type: none"> • Left: Ground • Right: +12 V DC 								
5	Cord Strip	For signal cable (DMX or Ethernet)								
6	DMX IN / OUT	RJ 45 port: <table style="width: 100%; border: none;"> <tr> <td style="width: 50%;">1: Universe 1+</td> <td style="width: 50%;">5: –</td> </tr> <tr> <td>2: Universe 1–</td> <td>6: –</td> </tr> <tr> <td>3: –</td> <td>7: Universe 1 GND</td> </tr> <tr> <td>4: –</td> <td>8: –</td> </tr> </table>	1: Universe 1+	5: –	2: Universe 1–	6: –	3: –	7: Universe 1 GND	4: –	8: –
1: Universe 1+	5: –									
2: Universe 1–	6: –									
3: –	7: Universe 1 GND									
4: –	8: –									
7	Ethernet (optional)	RJ 45 port								
8	DMX IN for Universe 1 (depending on production date)	<ul style="list-style-type: none"> • Left: GND • Middle: DMX Data – (for Universe 1) • Right: DMX Data + (for Universe 1) 								

4.2.3 WhiteBox F-1 MK II

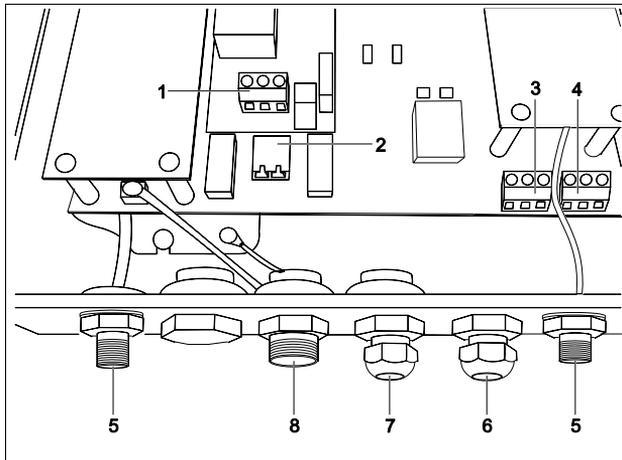

Fig. 4: Connectors and ports of the WhiteBox F-1 MK II

To ensure safe transmission of signals for outdoor use, the WhiteBox does not have XLR connectors. For this reason the connection of DMX signal cables differs slightly from the BlackBox models, which are for indoor use only.

To install the unit it is necessary to open the housing. See chapter "4.4.2 WhiteBox F-1", page 17.

No.	Port	Description
1	AC power input	$U_{AC} = 90\text{--}250\text{ V} / 50\text{--}440\text{ Hz}$: <ul style="list-style-type: none"> • Left: Outer conductor (L) • Middle: Ground (GND) • Right: Neutral conductor (N)
2	DC power input	Phoenix gold connector $U_{DC} = 12\text{ V}$: <ul style="list-style-type: none"> • Left: Ground • Right: $U_{DC} = +12\text{ V}$
3	DMX OUT for Universe 1	<ul style="list-style-type: none"> • Left: GND • Middle: DMX Data – (Universe 1 OUT) • Right: DMX Data + (Universe 1 OUT)
4	DMX IN for Universe 1	<ul style="list-style-type: none"> • Left: GND • Middle: DMX Data – (Universe 1 IN) • Right: DMX Data + (Universe 1 IN)
5	Antenna ports	Connector for antennas
6	Cord Strip	For signal cable (DMX or Ethernet)
7	Cord Strip	For DC power input (2)
8	Cord Strip	For AC power input (1)

4.3 LEDs

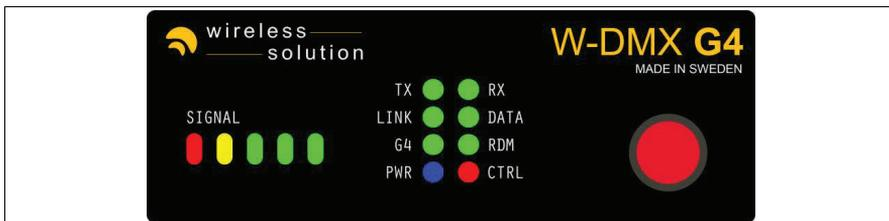

Fig. 5: LEDs of F-1

Name	LED signal	Description
Signal bar	–	RX (receiver) mode: Currently received signal strength TX (transmitter) mode: Yellow and green LEDs indicate output power
TX		<ul style="list-style-type: none"> • On: Unit in TX mode • Flashing: Transmitter in repeater mode
LINK		TX mode: <ul style="list-style-type: none"> • On: Normal operation • Flashing: Receivers are being unlinked • Rapid flashing: Receivers are being linked

4 BlackBox and WhiteBox F-1

Name	LED signal	Description
		RX mode: <ul style="list-style-type: none"> • Off: Unit is not linked to any transmitter. • On: Unit is linked to transmitter. • Rapid Flashing: Transmitters are being searched or linked transmitter is lost.
G4		<ul style="list-style-type: none"> • Off: Unit is in G3 mode. • On: Unit is in G4 or G4S 2.4 GHz mode. G4/G4S is indicated by red SIGNAL LED on the unit. • Flashing: Unit in G4S 5.8 GHz mode¹
SIGNAL		TX mode: <ul style="list-style-type: none"> • Off: Unit is in G4S mode. • On: Unit is in G4 mode. RX mode: Part of signal strength
PWR		Power on / off
RX		<ul style="list-style-type: none"> • On: Unit is in RX (receiver) mode. • Flashing: Receiver is in repeater mode.
DATA		Data is available at the input / output.
RDM		WhiteBox: included, BlackBox: optional <ul style="list-style-type: none"> • Off: No RDM data is available on output. • On: RDM data is available on output (RDM Downstream activated).
CTRL		<ul style="list-style-type: none"> • Off: Normal operation. • On: Switch between normal operation (CTRL LED off) and CTRL mode (flashing). • Flashing: CTRL mode is active To set the frequency band, see chapter "4.8 Switching CTRL modes", page 23.

¹ 5.8GHz is not available in all countries. For more info please contact Wireless Solution (see page 2).

4.4 Installing the unit

4.4.1 BlackBox F-1

1. Choose one of the following options to make the DMX connection:
 - Connect the DMX source to the XLR 5 pin DMX IN port, XLR 3 pin DMX IN port (BlackBox MK II only) or to the RJ 45 DMX IN port (BlackBox MK I only).
 - Connect the DMX fixture to the XLR 5 pin DMX OUT port, XLR 3 pin OUT port (BlackBox MK II only) or the RJ 45 DMX OUT port (BlackBox MK I only).

- Unit with optional Ethernet lighting protocol support:
Connect the Ethernet lighting source or output to the Ethernet in port.
2. Attach the supplied standard antenna(s) and standard adapter(s) or other suitable antenna(s) / adapter(s) available from Wireless Solution to the matching connector(s).

⚠ Warning

Risk of death by electrocution!

AC power connection must be carried out correctly.

- Make sure that only a qualified and trained electrician carries out AC power connection.
- Make sure the correct Schuko connector or other connector suitable for your country is used.

3. Choose one of the following options to connect the power to the unit:
 - Attach a suitable mains plug to the supplied power cord and connect the power supply to the AC power input.
 - Connect the power supply to the DC power input.
4. If required, attach the unit to the supplied mounting brackets or other mounting hardware available from Wireless Solution.

4.4.2 WhiteBox F-1

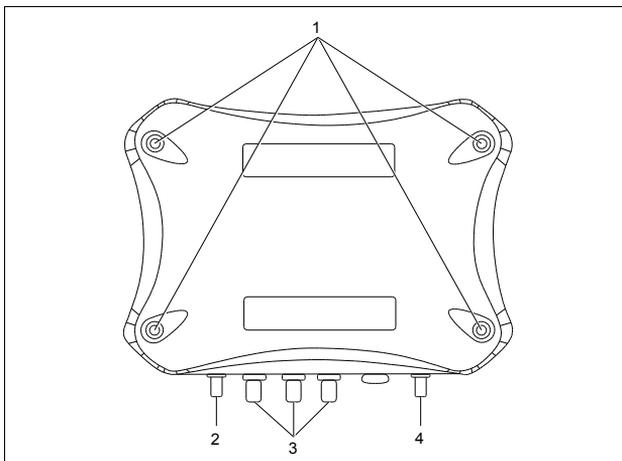

Fig. 6: Housing of the WhiteBox models

4 BlackBox and WhiteBox F-1

When connecting a WhiteBox model it is necessary to open the housing.

Warning

Risk of death by electrocution!

AC power connection must be carried out correctly.

- Make sure that only a qualified, trained electrician carries out AC power connection.
- Make sure the correct Schuko connector or other connector suitable for your country is used.

1. Remove the 4 screws (1) by turning them counterclockwise.
2. Open the housing.

Caution

Damage to the unit!

- Make sure no contact voltage is transferred when touching the connection cables.
- All non used Cable Glands need to be sealed to achieve IP65 rating.

3. Loosen the cord strips (3) by turning the screws counter-clockwise.
4. Put the cables through the cord strips (3).
5. When using AC, put the AC power cables into the socket (see chapter "4.2.2 WhiteBox F-1 MK I", page 13 or "4.2.3 WhiteBox F-1 MK II", page 14) and tighten the bolts of the socket.
6. Couple the connectors to the cables:
 - When using 12 V DC power, couple the 12 V DC power cable to the Phoenix gold connector
 - Couple RJ 45 connector:
 - MK I: to DMX signal cable (or Ethernet cable if option is installed and should be used).
 - MK II: to the socket (see chapter "4.2.3 WhiteBox F-1 MK II", page 14)
7. Fit the connectors within the sockets (see chapter "4.2.2 WhiteBox F-1 MK I", page 13 or "4.2.3 WhiteBox F-1 MK II", page 14).
8. Fit the cord strips by turning them clockwise.
9. If the FFC cable to the overlay is loose:
 - rotate the lid by 180°,
 - insert the FFC cable,
 - secure the FFC cable in the connector
 - rotate back the lid before you close the housing.

10. Close the housing.
11. Tighten the 4 screws (1) by turning them clockwise.

4.5 Switching FLEX modes

The FLEX mode determines if the unit is used in Transmit Mode (TX) or Receive Mode (RX).

To switch the FLEX mode, proceed as follows:

1. Disconnect the power cable.



2. Press and hold the red function button (1) on the front panel.
3. Reconnect the power cable.
4. Release the red function button (1).

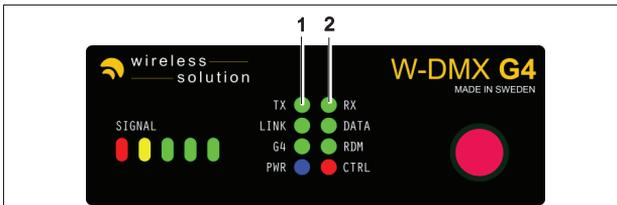

- The mode is switched. The LEDs indicate the current mode: either TX (1) or RX (2):

4 BlackBox and WhiteBox F-1

4.6 Operation as a transmitter

- ✓ The unit is in Transmit Mode (TX) working as a transmitter.

4.6.1 Prerequisites for successful linking with receivers

Hint

The figures are maximum figures and depend on output level and environment. Local settings may be required.

1. For advanced settings and projects, contact your distributor.

- ✓ Max. distance to transmitter (air):
 - 200 m (Micro units)
 - 500 m (BlackBox, WhiteBox and ProBox in ETSI mode)
 - 750 m (BlackBox, WhiteBox and ProBox in FCC mode)

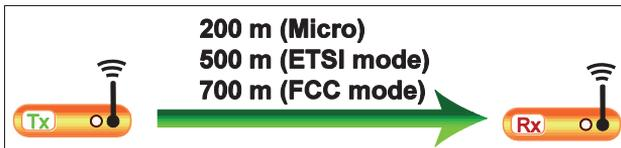

- ✓ Distance to transmitter (glass): up to 500 m

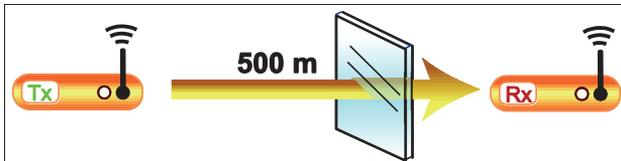

- ✓ Distance to transmitter (wall, except concrete): up to 350 m
- ✓ Distance to transmitter (concrete): up to 150 m

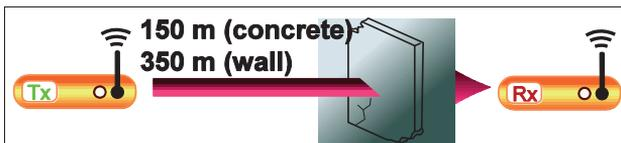

- ✓ Position above crowds: min. 1 m
- ✓ Position above trees: min. 1 m

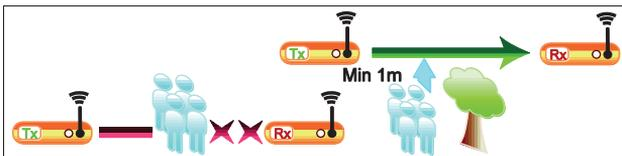

4.6.2 Linking receivers

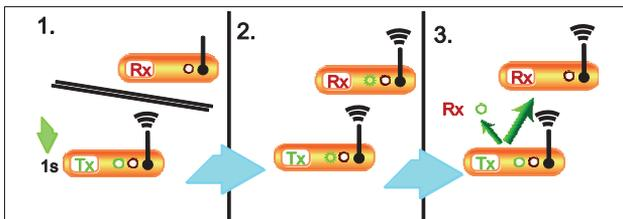

Hints

You can link receivers at any time, also during operation. During the linking procedure the DMX transmission is interrupted.

Linking a transmitter to a receiver means that any DMX data put into the transmitter is output at the receiver.

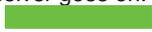
1. Power on the receivers you want to link.
2. Ensure that the receiver is not connected to any other transmitter, i.e., the LINK LED on the receiver is off: . If required, see chapter "4.7.2 Unlinking from transmitters", page 23.
3. Press the red function button of the transmitter momentarily (1 second).
 - ➔ The transmitter scans for all unlinked receivers for a period of about 5 seconds. The LINK LED flashes rapidly: 
 - ➔ If the connection is successful, the LINK LED on the receiver goes on. If DMX input is available, the DATA LED goes on as well: 
 - ➔ If the connection fails, check the position of the receiver, see chapter "4.6.1 Prerequisites for successful linking", page 20.
 - ➔ The signal bar on the receiver indicates the received signal strength.

4 BlackBox and WhiteBox F-1

4.6.3 Unlinking all receivers

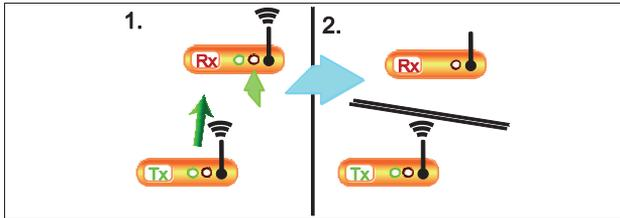

Use this procedure to unlink all receivers connected with the unit.

1. Press the red function button on the transmitter for 3 seconds, until the LINK LED flashes slowly.

- The LINK LED on the transmitter flashes slowly: 
- The signal bar of the receivers fall back to zero.
- LINK LED on receivers goes off.
- All connected receivers are unlinked.

Hint

To unlink one specific receiver, press and hold the red function button on the specific receiver for 3 seconds, until the LINK LED is off.

4.7 Operation as a receiver

- ✓ The unit is in Receive Mode (RX), working as a receiver.

4.7.1 Linking with transmitters

Hint

You can link receivers at any time, also during operation. During the linking procedure the DMX transmission is interrupted.

1. Power on the receiver.
2. Ensure that the receiver is not connected to any other transmitter, i.e., the LINK LED on the receiver is off:
If required, see chapter "4.7.2 Unlinking from transmitters", page 23.
3. Press the red function button of the transmitter momentarily (1 second).
 - The transmitter scans for all unlinked receivers for a period of about 5 seconds. The LINK LED flashes rapidly: 



- If the connection is successful, the LINK LED on the receiver goes on. If DMX input is available, the DATA LED goes on as well:
- If the connection fails, check the position of the receiver, see chapter "4.6.1 Prerequisites for successful linking", page 20.
- The signal bar on the receiver indicates the received signal strength.

4.7.2 Unlinking from transmitters

1. Press the red function button on the receiver until the LINK LED goes off:
- The receiver is unlinked and now can be linked, see chapter "4.6.2 Linking receivers" on page 21.

4.8 Switching CTRL modes

The CTRL mode determines which frequency band is used and if Legacy G2 and G3 units can be used in the wireless environment.

Wireless DMX G4 units in Transmit Mode (TX) can switch the CTRL mode of the entire system:

- G3 2.4 GHz mode (Legacy G2 and G3 units)
- G4 2.4 GHz mode
- G4S 2.4 GHz mode
- G4S 5.8 GHz mode

Hint

- G4S 5.8 GHz mode depends on local regulations.
- Unlink receivers before switching CTRL mode. The G4 receivers will automatically detect the mode the transmitters are in and adapt to it during linking.
- G4S 2.4 GHz Repeater mode and G4S 5.8 GHz Repeater mode can only be set with dongle or RDM command.

4 BlackBox and WhiteBox F-1

To change the CTRL mode, proceed as follows:

- ✓ The unit is in Transmit Mode (TX), working as a transmitter.

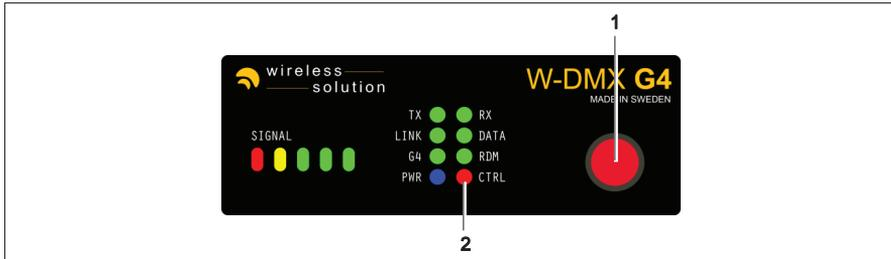

1. Press and hold the red function button (1) on the front panel for at least 10 seconds.
- ➔ The CTRL LED (2) blink. TX, RX, DATA and LINK LEDs are rotating.

Hints

- Do NOT release the red function button (1) until TX, RX, DATA and LINK start rotating and CTRL is blinking.
- Keep holding the red function button (1) even if the LINK LED starts blinking. This allows you to go through the unlink mode without unlinking.
- Old G4 software indicate CTRL mode with CTRL and TX on, RX, DATA and LINK off. Therefore, to exit control mode with Old G4 software, unplug power.
- Old G4 software is compatible only in G3 and G4 mode. G3 units are compatible only in G3 mode.

2. Release the red function (1) button.
3. Press the red function button (1) repeatedly until the desired mode is displayed via the status of the following LEDs:

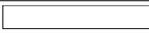
	G4 LED	RED SIGNAL LED
G3 2.4 GHz mode		
G4 2.4 GHz mode		
G4S 2.4 GHz mode		 (on transmitter)
G4S 5.8 GHz mode		 (on transmitter)

- ➔ The desired mode is set.
- 4. Press and hold the red function button (1) for 3 seconds.
- ➔ The unit exits CTRL mode (configuration) and CTRL LED turns off.
- ➔ Normal operation restarts.

5 BlackBox and WhiteBox R-512

BlackBox and WhiteBox are functionally identical. The BlackBox is intended for indoor usage, the WhiteBox for outdoor usage.

5.1 Scope of delivery

5.1.1 BlackBox R-512

- 1 x BlackBox R-512 device
- 1 x user manual
- 1 x antenna adapter
- 1 x antenna indoor (2 dBi)
- 2 x mounting bracket
- 1 x Phoenix gold connector
- 1 x power cable without plug (MK I only)

5.1.2 WhiteBox R-512

- 1 x WhiteBox R-512 device
- 1 x user manual
- 1 x outdoor antenna (2 dBi)
- 1 x Phoenix gold connector

5.2 Connectors and ports

5.2.1 BlackBox R-512

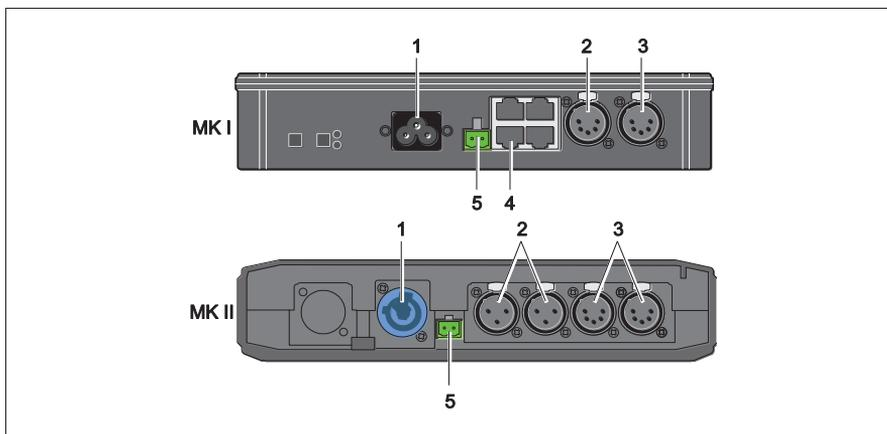

Fig. 7: Connectors and ports of BlackBox R-512

5 BlackBox and WhiteBox R-512

No.	Port	Description
1	AC power input	U _{AC} = 90–250 V / 50–440 Hz MK I: IEC 2.5A connector MK II: PowerCon 20A connector
2	DMX OUT	<ul style="list-style-type: none"> • MK I: XLR female 5 pin • MK II: XLR female 3 pin
3	DMX OUT	XLR female 5 pin
4	DMX OUT	RJ 45 port: 1: Universe 1+ 5: – 2: Universe 1– 6: – 3: – 7: Universe 1 GND 4: – 8: –
5	DC power input	Input for Phoenix gold connector: <ul style="list-style-type: none"> • Left: Ground • Right: +12 V DC

5.2.2 WhiteBox R-512

Connectors and ports of the WhiteBox R-512 are identical to the WhiteBox F-1:

- MK I: See chapter "4.2.2 WhiteBox F-1 MK I", page 13.
- MK II: See chapter "4.2.3 WhiteBox F-1 MK II", page 14.

5.3 LEDs

LED signals are identical to F-1, see chapter 4.3 LEDs", page 15.

Hint

- The R-512 does not have transmission functionality.
- The R-512 does not provide CTRL mode, because the receiver detects the right mode automatically.

5.4 Installing the unit

Installation is identical to:

- BlackBox F-1: See chapter "4.4.1 BlackBox F-1", page 16.
- WhiteBox F-1: See chapter "4.4.2 WhiteBox F-1", page 17.

5.5 Operation as a receiver

Operation as a receiver is identical to the BlackBox and WhiteBox F-1, see chapter "4.7 Operation as a receiver", page 22.



6 BlackBox and WhiteBox F-2

BlackBox and WhiteBox are functionally identical. The BlackBox is intended for indoor usage, the WhiteBox for outdoor usage.

6.1 Scope of delivery

6.1.1 BlackBox F-2

- 1 x BlackBox F-2 device
- 1 x user manual
- 2 x antenna adapter
- 2 x antennas indoor (2 dBi)
- 2 x mounting bracket
- 1 x Phoenix gold connector
- 1 x power cable without plug (MK I only)

6.1.2 WhiteBox F-2

- 1 x WhiteBox F-2 device
- 1 x user manual
- 2 x outdoor antennas (2 dBi)
- 1 x Phoenix gold connector

6.2 Connectors and ports

6.2.1 BlackBox F-2

 Caution
Damage to the unit! Connecting more than one DMX Universe to each pair of Universe connectors (XLR / RJ 45) at a time damages the unit.
<ul style="list-style-type: none">• Connect only one DMX Universe input to each pair of Universe connectors (XLR / RJ 45) at a time.

No.	Port	Description
8	DC power input	Input for Phoenix gold connector: <ul style="list-style-type: none"> • Left: Ground • Right: +12 V DC
9	DMX OUT / bypass	XLR female 5 pin output for Universe 2
10	DMX IN	XLR male 5 pin input for Universe 2

6.2.2 WhiteBox F-2 MK I

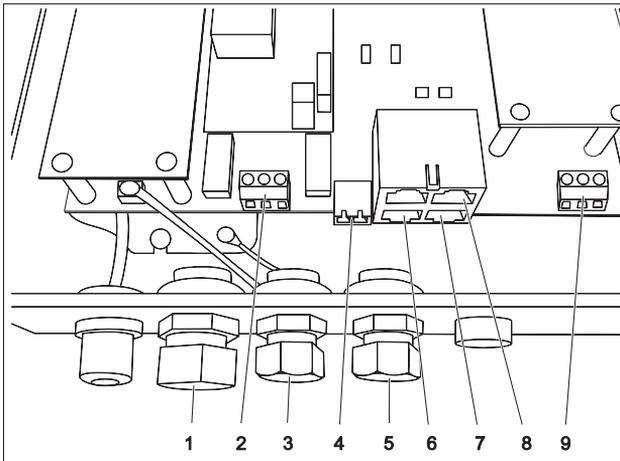

Fig. 9: Connectors and ports of the WhiteBox F-2 MK I

To ensure safe transmission of signals for outdoor use, the WhiteBox does not have XLR connectors. For this reason the connection to DMX signal cables differs slightly to the BlackBox models, which are for indoor use only.

No.	Port	Description
1	Cord Strip	For AC power input (2)
2	AC power input	$U_{AC} = 90\text{--}250\text{ V} / 50\text{--}440\text{ Hz}$ <ul style="list-style-type: none"> • Left: Outer conductor (L) • Middle: Ground (GND) • Right: Neutral conductor (N)
3	Cord Strip	For DC power input (4)
4	DC power input	Phoenix gold connector 12 V DC <ul style="list-style-type: none"> • Left: Ground • Right: +12 V DC
5	Cord Strip	For signal cable (DMX or Ethernet)

No.	Port	Description
1	AC power input	U _{AC} = 90–250 V / 50–440 Hz <ul style="list-style-type: none"> • Left: Outer conductor (L) • Middle: Ground (GND) • Right: Neutral conductor (N)
2	DC power input	Phoenix gold connector 12 V DC <ul style="list-style-type: none"> • Left: Ground • Right: +12 V DC
3	DMX IN/OUT for Universe 2	<ul style="list-style-type: none"> • Left: GND • Middle: DMX Data – (Universe 2) • Right: DMX Data + (Universe 2)
4	DMX OUT for Universe 1	<ul style="list-style-type: none"> • Left: GND • Middle: DMX Data – (Universe 1 OUT) • Right: DMX Data + (Universe 1 OUT)
5	DMX IN for Universe 1	<ul style="list-style-type: none"> • Left: GND • Middle: DMX Data – (Universe 1 IN) • Right: DMX Data + (Universe 1 IN)
6	Antenna port	Connector for antenna of Universe 1
7	Cord Strip	For signal cable (DMX or Ethernet)
8	Cord Strip	For DC power input (2)
9	Cord Strip	For AC power input (1)
10	Antenna port	Connector for antenna of Universe 2

6.3 LEDs

The F-2 units are equipped with two identical sets of LEDs and red function buttons:

- Left: Universe 1
- Right: Universe 2

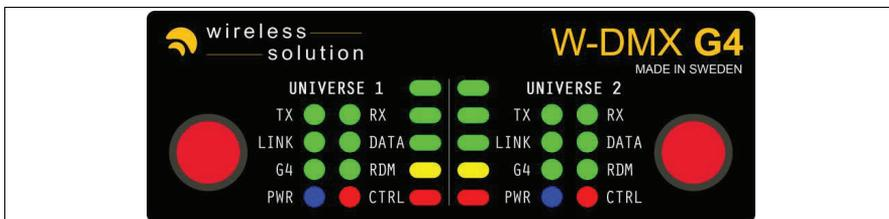

Fig. 11: LEDs of F-2

For the description of the LED meanings, see chapter "4.3 LEDs", page 15.

6 BlackBox and WhiteBox F-2

6.4 Installing the unit

Installation is identical to:

- BlackBox F-1: see chapter "4.4.1 BlackBox F-1", page 16.
- WhiteBox F-1: see chapter "4.4.2 WhiteBox F-1", page 17.

Hint

- You have to install two antennas.
- On BlackBox MK I and WhiteBox MK I, Universe 2 is only available via RJ 45 port.

6.5 Switching FLEX modes

The FLEX mode determines if the unit is used in Transmit Mode (TX), Repeater Mode (TX flashing) or Receive Mode (RX).

To switch the FLEX mode, proceed as follows:

1. Disconnect the power cable.

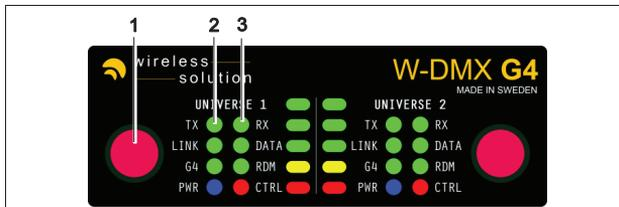

2. Press and hold the left red function button (1) on the front panel (Universe 1).
3. Reconnect the power cable.
4. Release the red function button (1).
 - ➔ The FLEX mode is switched. The LEDs indicate the current mode: either TX (2) or RX (3).
5. If necessary, repeat the procedure for Universe 2 on the right side of the front panel. Functional elements are identical to the left side (Universe 1).

6.6 Operation as a transmitter

The operation as a transmitter is identical to the BlackBox and WhiteBox F-1, see chapter "4.6 Operation as a transmitter", page 20.

Carry out the procedures for each Universe individually.

<p> Hints</p>
<p>When you link the receivers for Universe 1, power-on only the respective receivers for Universe 1.</p> <p>Once the receivers for Universe 1 are connected, you can power-on the receivers for Universe 2 and link them.</p> <p>Universe 2 will have a delayed start after Universe 1 is in operation.</p> <p>When linking Universe 1, Universe 2 will stop transmitting.</p> <p>When linking Universe 2, Universe 1 will stop transmitting.</p>
<p>Operating an F-2 as a single universe transmitter, put Universe 2 into RX mode and keep Universe 2 unlinked to avoid interference.</p>

6.7 Operation as a receiver

The operation as a receiver is identical to the BlackBox and WhiteBox F-1, see chapter "4.7 Operation as a receiver", page 22.

Carry out the procedures for each Universe individually.

6.8 Operation as a repeater

Since the F-2 unit provides 2 Universes, it is possible to use the unit as a repeater.

✓ W-DMX Co-Existence dongle or RDM command is available.

<p> Hints</p>
<p>If Universe 1 loses link in active repeater mode:</p> <ul style="list-style-type: none"> • LINK LED of Universe 1 will flash rapidly. • Universe 2 will stop sending radio. • Receivers linked to the repeater also will lose link.
<p>RDM is not available when running G4S in repeater mode. You have only access to master transmitter.</p>



6 BlackBox and WhiteBox F-2

 Hints
Master transmitter is the initial transmitter that receive DMX input on cable.
Universe 2 will have a delayed start some seconds after Universe 1 has received LINK. <ul style="list-style-type: none">• If required to operate with G3 receivers or old G4 receivers, repeater can work in G3 mode as well. This function requires G4S software on the repeater.

1. Set Universe 1 and Universe 2 into transmitter mode, see chapter "6.5 Switching FLEX modes", page 32.
2. Use the W-DMX Co-Exists dongle or a RDM command:
 - To set the master transmitter into "G4S repeater mode".
 - To set the Universe 2 of the F-2 unit into "G4S repeater mode".
3. Set Universe 1 into receiver mode, see chapter "6.5 Switching FLEX modes", page 32.
4. Link Universe 1 to the master transmitter.
5. Link the receivers to Universe 2 of the F-2 unit.

6.9 Switching CTRL modes

The CTRL mode determines which frequency band is used in G4 mode and if Legacy G2/G3 units can be used in the wireless environment.

Switching CTRL mode is identical to the BlackBox and WhiteBox F-1, see chapter "4.8 Switching CTRL modes", page 23.

 Hint
The F-2 unit provides 2 Universes. <ul style="list-style-type: none">• Carry out the procedures for each Universe individually.• Keep the 2 Universes in the same mode to avoid interference.• Power cycle the box after changing CTRL mode, to let Universe 2 receive a complete configuration.

7 Micro units

7.1 Micro F-1 Lite

7.1.1 Scope of delivery

- 1 x Micro F-1 Lite device
- 1 x user manual
- 1 x external power supply unit
- adapters for several electrical outlets
- 1 x hook-and-loop belt

7.1.2 Connectors and ports

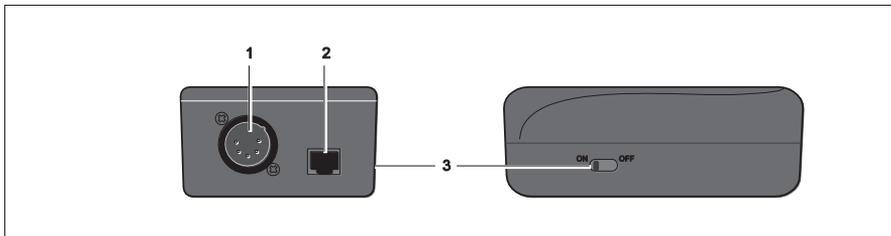

Fig. 12: Micro F-1 Lite, side view

No.	Port	Description
1	DMX IN	XLR male 5 pin. If you want to use the unit as a receiver, you can buy an optional XLR 5-pin female-to-female adapter.
2	DC power input	RJ 45 port: +12 V DC (Connector for EMS120050-P19-SZ)
3	Power Switch	Turn on / off the unit.

7.1.3 LEDs

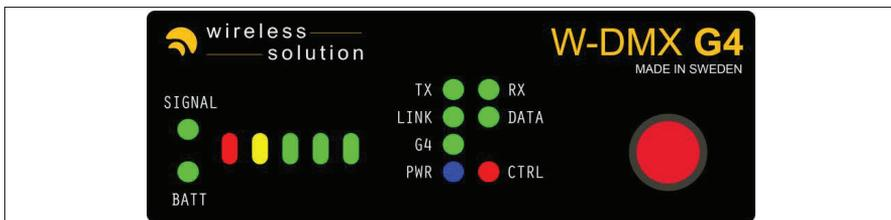

Fig. 13: LEDs of Micro F-1 Lite

7 Micro units

SIGNAL/BATT:

- SIGNAL identifies if the signal strength or battery power is displayed on the LED bar.
- BATT is a coming feature.

Other LED signals are identical to F-1, see chapter 4.3 LEDs", page 15.

 Hint
Micro F-1 Lite does not have the G4S 5.8 GHz mode.

7.1.4 Installing the unit

1. Choose one of the following options to make the DMX connection:
 - Connect the DMX source to the DMX IN / OUT port.
 - Connect the DMX fixture to the DMX IN / OUT port.
2. Connect the power supply to the DC power input.

7.1.5 Switching FLEX modes

The FLEX mode determines if the unit is used in Transmit Mode (TX) or Receive Mode (RX). Switching the FLEX mode is identical to the BlackBox F-1, see "4.5 Switching FLEX modes", page 19.

7.1.6 Operation as a transmitter

The operation as a transmitter is identical to the BlackBox and WhiteBox F-1, see chapter "4.6 Operation as a transmitter", page 20.

7.1.7 Operation as a receiver

The operation as a receiver is identical to the BlackBox and WhiteBox F-1, see chapter "4.7 Operation as a receiver", page 22.

7.1.8 Switching CTRL modes

The CTRL mode determines which frequency band is used and if Legacy G2/G3 units can be used in the wireless environment.

Switching CTRL modes is identical to the BlackBox and WhiteBox F-1, see chapter "4.8 Switching CTRL modes", page 23.

 Hint
This unit does not support the G4S 5.8 GHz mode.



7.1.9 Battery option

The W-DMX G4 Micro units are equipped with a holder for 6 AAA batteries. If batteries are installed in the unit and 12 V DC power is disconnected, the unit runs on battery power.

Indication of battery status is a coming feature.

The BATT and SIGNAL LED light up alternately every 5 seconds:

- When the BATT LED is on, the signal bars indicate battery status.
- When the SIGNAL LED is on, the signal bars indicate signal strength.

On average, the W-DMX receiver can receive for approximately from 4 to 8 hours in battery mode. The exact battery life depends on the brand of batteries and mode of the W-DMX unit.

Hint

We recommend testing the discharge time of your selected batteries before using them in a show environment.

The W-DMX G4 Micro units are compatible with rechargeable batteries (down to $U_{DC} = 1.2$ V per cell).

Hint

Batteries cannot be charged with the Micro units.
Please use an appropriate battery charger.

7 Micro units

7.2 Micro R-512 Lite

The unit is provided with a battery option, see chapter "7.1.9 Battery option", page 37.

7.2.1 Scope of delivery

- 1 x Micro R-512 Lite device
- 1 x user manual
- 1 x external power supply unit
- adapters for several electrical outlets
- 1 x hook-and-loop belt

7.2.2 Connectors and ports

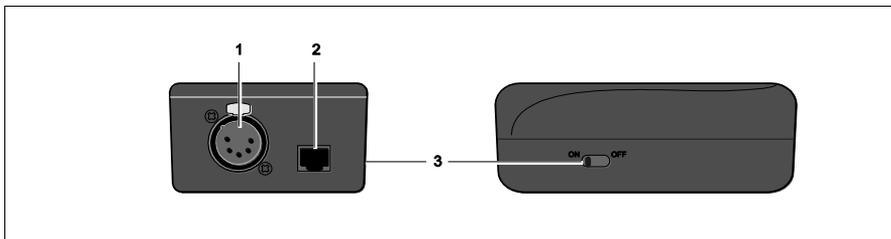

Fig. 14: Micro R-512 Lite, side view

No.	Port	Description
1	DMX OUT	XLR female 5 pin
2	DC power input	RJ 45 port: +12 V DC (Connector EMS120050-P19-SZ)
3	Power Switch	Turn on / off the unit.

7.2.3 LEDs

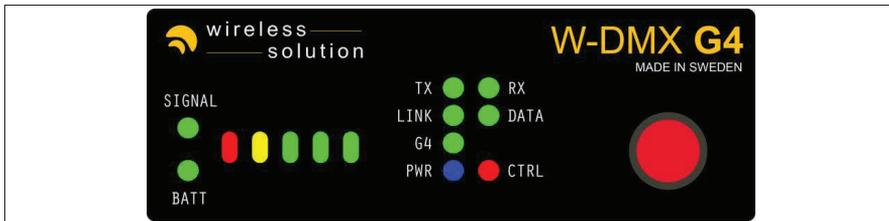

Fig. 15: LEDs of Micro R-512 Lite

SIGNAL/BATT: Identifies if the signal strength or battery power is displayed on the LED bar.

BATT is a coming feature.

Other LED signals are identical to F-1, see chapter "4.3 LEDs", page 15.

Hint

- Micro R-512 Lite does not have the G4S 5.8 GHz mode.
- Micro R-512 Lite does not have a transmission function, LED "TX" is never used.
- Micro R-512 Lite does not have RDM support.

7.2.4 Installing the unit

Installation is identical to the Micro F-1 Lite, see chapter "7.1.4 Installing the unit", page 36.

7.2.5 Operation as a receiver

The operation as a receiver is identical to the BlackBox and WhiteBox F-1, see chapter "4.7 Operation as a receiver", page 22.

8 ProBox F-2500

8 ProBox F-2500

8.1 Scope of delivery

- 1 x ProBox F-2500 device
- 1 x user manual
- 2 x antenna adapter
- 2 x antennas indoor (2 dBi)
- 1 x Phoenix gold connector

8.2 Connectors and ports

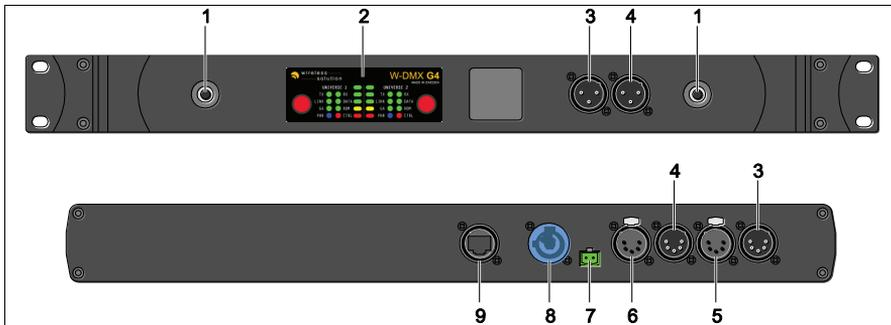

Fig. 16: Connectors and ports of ProBox F-2500
(Upper picture: front panel; lower picture: connector rear)

No.	Port	Description
1	Antenna Ports	Connector for antennas Universe 1: left, Universe 2: right
2	Display & Buttons	See chapter "4.3 LEDs", page 15
3	DMX IN for Universe 1	<ul style="list-style-type: none"> • Front: XLR male 3 pin • Back: XLR male 5 pin
4	DMX IN for Universe 2	<ul style="list-style-type: none"> • Front: XLR male 3 pin • Back: XLR male 5 pin
5	DMX OUT for Universe 1	XLR female 5 pin
6	DMX OUT for Universe 2	XLR female 5 pin
7	DC power input	Input for Phoenix gold connector: <ul style="list-style-type: none"> • Left: Ground • Right: +12 V DC

No.	Port	Description
8	AC power input	$U_{AC} = 90\text{--}250\text{ V} / 50\text{--}440\text{ Hz}$ PowerCon 20A connector
9	Ethernet	EtherCon RJ 45 port Supports Power over Ethernet 802.3af Includes an embedded BlueBox

8.3 LEDs

The ProBox F-2500 is equipped with two identical sets of LEDs and red function buttons:

- Left: Universe 1
- Right: Universe 2

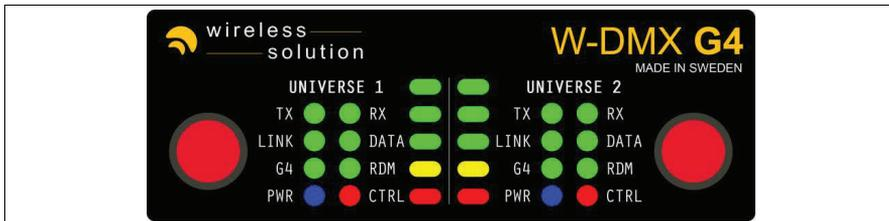

Fig. 17: LEDs of ProBox F-2500

For the description of the LED meanings, see chapter "4.3 LEDs", page 15.

8.4 Installing the unit

Installation is identical to the BlackBox F-1, see chapter "4.4.1 BlackBox F-1", page 16.

8.5 Switching FLEX modes

The FLEX mode determines if the unit is used in Transmit Mode (TX) or Receive Mode (RX). Switching FLEX mode is identical to the BlackBox and WhiteBox F-2, see chapter "6.5 Switching FLEX modes", page 32.

8.6 Operation as a transmitter

The operation as a transmitter is identical to the BlackBox and WhiteBox F-1, see chapter "4.6 Operation as a transmitter", page 20.

Carry out the procedures for each Universe individually.

8 ProBox F-2500

Hint

When you link the receivers for Universe 1, power on only the respective receivers for Universe 1.

Once the receivers for Universe 1 are connected, you can power on the receivers for Universe 2 and link them.

8.7 Operation as a receiver

The operation as a receiver is identical to the BlackBox and WhiteBox F-1, see chapter "4.7 Operation as a receiver", page 22.

8.8 Operation as a repeater

Since the ProBox F-2500 provides 2 Universes, it is possible to use the unit as a repeater. The operation is identical to BlackBox and WhiteBox F-2, see chapter "6.8 Operation as a repeater", page 33.

8.9 Switching CTRL modes

The CTRL mode determines which frequency band is used in G4 mode and if Legacy G2/G3 units can be used in the wireless environment.

Switching CTRL mode is identical to the BlackBox and WhiteBox F-1, see chapter "4.8 Switching CTRL modes", page 23.

Hint

The ProBox F-2500 provides 2 Universes.

- Carry out the procedures for each Universe individually.
- Keep the two universes in the same mode to avoid interference.

9 Technical data

9.1 BlackBoxes (BB) and WhiteBoxes (WB) F-1, R-512 and F-2

BlackBox (in mm):

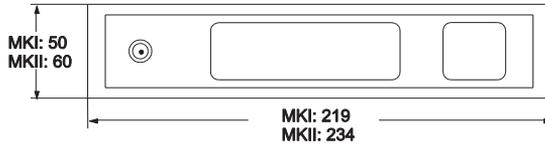

WhiteBox (in mm):

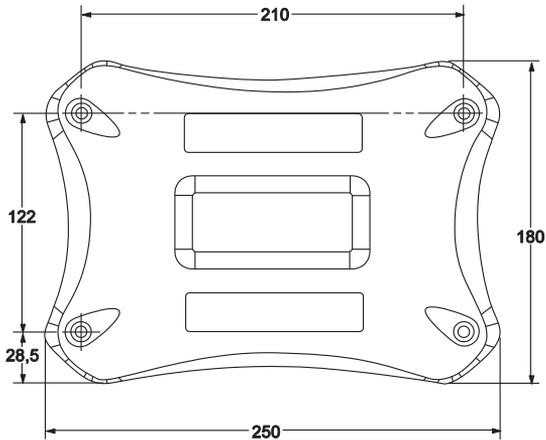

		BB F-1	WB F-1	BB R-512	WB R-512	BB F-2	WB F-2
Electrical data							
Regulations complied with		Certified Worldwide (FCC, ETL, ETSI, CE, Japan, Russia)					
High voltage input		$U_{AC} = 90-250 \text{ V} / 50-440 \text{ Hz}$					
Low voltage input		$U_{DC} = 12 \text{ V}$					
Average current (TX mode)		$450 - 700 \text{ mA} / 12 \text{ V}_{DC}$					
Average current (RX mode)		$200 \text{ mA} / 12 \text{ V}_{DC}$					
DC power supply		Phoenix gold connector					
Dimensions							
Width x height x depth	MK I	219 x 131 x 50 mm	250 x 180 x 67.5 mm	219 x 131 x 50 mm	250 x 180 x 67.5 mm	219 x 131 x 50 mm	250 x 180 x 67.5 mm
	MK II	234 x 150 x 60 mm	–	234 x 150 x 60 mm	–	234 x 150 x 60 mm	–
Weight		1005 g	1200 g	1005 g	1200 g	1005 g	1200 g

9 Technical data

	BB F-1	WB F-1	BB R-512	WB R-512	BB F-2	WB F-2
Environmental conditions						
Ambient temperature range (standard)	0 °C to 45 °C				0 °C to 40 °C	
Ambient Temperature range (12 V _{DC})	0 °C to 55 °C					
Humidity	90 %					
Input protocols						
DMX512	Yes					
RDM (1)	Yes		Optional		Yes	
Ethernet	Optional		No		Optional	
Streaming ACN	Optional		No		Optional	
Art-Net 1 / Art-Net 2 / Art-Net 3	Optional		No		Optional	
Radio performance						
Loss of date behavior	As wire					
Output protocols						
DMX512	Yes					
RDM (1)	Yes		Optional		Yes	
Streaming ACN	Optional		No		Optional	
Art-Net 2	Optional		No		Optional	
Radio technologies						
G3/G4/G4S 2.4 GHz	Yes					
G4S 5.8 GHz	Yes – depending of local regulations, not in EU					
Adaptive Frequency Hopping	Yes					
W-DMX G3 compatibility	Yes					
License free	Yes					
W-DMX Datasafe Redundancy	Yes					
External antenna	Yes					
Standard range	Up to 750 m (standard antenna)					
Expandable range	Unlimited (optional antennas)					
Latency	< 5 ms					
Sensitivity (0.1% PER)	-97 dBm					
Modulation method	GFSK					
Max. power 2.4 GHz EIRP (2)	400 mW					
Max. power 5.8 GHz EIRP (2)	400 mW					
DMX capabilities						
Max. number of Universes	32				64	
Input / output Opto Isolation	Yes		No		Yes	
Fully compliant USITT DMX512A	Yes					
W-DMX Invisi-wire	Yes					
Product functionality						
Front panel control	Yes					
W-DMX Uglybox compatible	Yes					
W-DMX Dongle compatible	Yes					
Free software updates	Yes					
Update over Dongle	Yes					
PC configurable	Yes					
Configurable over RDM	Yes		Optional		Yes	

9.2 MicroBox F-1 Lite and MicroBox R-512 Lite

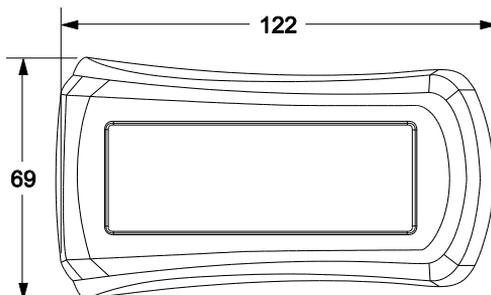

	MicroBox F-1 Lite	MicroBox R-512 Lite
Electrical data		
Regulations complied with	Certified Worldwide (FCC, ETL, ETSI, CE, Japan, Russia)	
High voltage input	U _{AC} = 90 - 250 V (external power supply)	
Low voltage input	U _{DC} = 12-24 V	
Average current (TX mode)	450 to 700 mA / 12 V	
Average current (RX mode)	200 mA / 12 V	
DC power supply	Connector EMS120050-P19-SZ	
Dimensions		
Width x height x depth	122 x 69 x 43 mm	
Weight (without battery)	130 g	
Environmental conditions		
Ambient temperature range (standard)	0 °C to 55 °C	
Ambient temperature range (12 V _{DC})	0 °C to 55 °C	
Humidity	90 %	
Input protocols		
DMX512	Yes	
RDM (1)	Yes	No
Ethernet	No	
Loss of date behavior	As wire	
Output protocols		
DMX512	Yes	
RDM (1)	Yes	No
Radio technologies		
2.4 GHz	Yes	
5.8 GHz	No	
DMX capabilities		
Adaptive Frequency Hopping	Yes	
W-DMX G3 compatibility	Yes	
License free	Yes	
W-DMX Datasafe Redundancy	Yes	

9 Technical data

	MicroBox F-1 Lite	MicroBox R-512 Lite
Radio performance		
External antenna		No
Standard range		Up to 200 m
Latency		< 5 ms
Sensitivity (0.1% PER)		-97 dBm
Modulation method		GFSK
Max. power 2.4 GHz EIRP (2)		250 mW
Max. number of Universes	4	4
Input / output Opto Isolation		No
Fully compliant USITT DMX512A		Yes
W-DMX Invisi-wire		Yes
Product functionality		
Front panel control		Yes
W-DMX Uglybox compatible		Yes
W-DMX Dongle compatible		Yes
Free software updates		Yes
Update over Dongle		Yes
PC configurable		Yes
Configurable over RDM	Yes	No

9.3 ProBox F-2500

ProBox F-2500	
Electrical data	
Regulations complied with	Certified Worldwide (FCC, ETL, ETSI, CE, Japan, China , Russia)
High voltage input	$U_{AC} = 90\text{--}250\text{ V} / 50\text{--}440\text{ Hz}$
Low voltage input	$U_{DC} = 12\text{--}24\text{ V}$
Average current (TX mode)	450 to 700 mA / 12 V
Average current (RX mode)	200 mA / 12 V
DC power supply	Phoenix gold connector
Dimensions	
Format	19" rack format. Height: 1 U, depth: 120 mm
Weight	800 g
Environmental conditions	
Ambient temperature range (standard)	0 °C to 45 °C
Ambient temperature range (12 V _{DC})	0 °C to 55 °C
Humidity	90 %
Input protocols	
DMX512	Yes
RDM (1)	Yes
Ethernet / PoE	Yes
Streaming ACN (incl. ETCNet3)	Yes
Art-Net 1 / Art-Net 2 / Art-Net 3	Yes
Loss of date behavior	As wire
Output protocols	
DMX512	Yes
RDM (1)	Yes
Streaming ACN (incl. ETCNet3)	Yes
Art-Net 2	Yes
Radio technologies	
2.4 GHz	Yes
5.8 GHz	Yes – depending on local regulations, not in EU
Adaptive Frequency Hopping	Yes
W-DMX G3 compatibility	Yes
License free	Yes
W-DMX Datasafe Redundancy	Yes
Radio performance	
External antenna	Yes
Standard range	Up to 750 m
Expandable range	Unlimited
Latency	< 5 ms
Sensitivity (0.1% PER)	–97 dBm
Modulation method	GFSK
Max. power 2.4 GHz EIRP (2)	400 mW
Max. power 5.8 GHz EIRP (2)	400 mW

9 Technical data

ProBox F-2500	
DMX capabilities	
Max. number of Universes	64
Input / output Opto Isolation	Yes
Fully compliant USITT DMX512A	Yes
W-DMX Invisi-wire	Yes
Product functionality	
Front panel control	Yes
W-DMX Uglybox compatible	Yes
W-DMX Dongle compatible	Yes
Free software updates	Yes
Update over Dongle	Yes
PC configurable	Yes
Configurable over RDM	Yes

(1) RDM only available in G4S radio modes, except for configuration of transmitter. RDM needs to be activated, "Enable RDM Downstream" at both transmitter and receiver, can be performed with Co-Existence dongle or RDM command.



10 FAQ – Frequently asked questions

Is W-DMX compatible with other systems on the market?

Today there is no standard for wireless transmission of DMX signals and there is no possibility of mixing different brands of wireless DMX solutions in a system. For example, you cannot use a Martin® Wireless DMX-512 - Pro Diversity® with Interactive Technologies® Cuelink® even though they use a similar type of physical radio transmission standard. Because of this, no wireless-DMX brand today is compatible with another.

Is W-DMX built on Bluetooth®?

No. It is built on standard radio components with a GSM influenced radio system protocol. Bluetooth® lacks the range needed.

Is W-DMX plug and play?

Yes. W-DMX doesn't need any configuration for IP address and net mask like WLAN. W-DMX is "plug and play".

Is it made for use outdoors?

Yes. Receivers, transceivers, repeaters and boosters are all available in outdoor versions, all with an IP65 rating.

What are the differences between the indoor and outdoor models?

The outdoor units would use a different antenna. And, of course, the outdoor units are rated IP65 weatherproof.

What is IP65?

IP65 is a rating of how weather resistant an item is. IP65 means that the device is totally protected against dust and protected against low pressure jets of water from all directions. On the Outdoor models, WhiteBox, the end user open the box during the installation, care need to be taken to ensure that cable glands and lid is properly sealed to ensure that the installed unit is IP65 rated.

What is the difference between the standard and the pro models?

The pro model W-DMX have a built support for S-ACN and Art-Net, and a built in RDM controller in the embedded BlueBox module, it has also a built in Power over Ethernet module

Do the transmitters and receivers have built-in power supplies?

All units have built-in universal power supplies that can operate from a supply range of $U_{AC} = 90\text{--}250\text{ V}$, $50\text{--}440\text{ Hz}$ (except the MicroBox, F-1 Lite and R-512 Lite which requires a $12\text{--}24\text{ V}_{DC}$ external supply). The BlackBox, WhiteBox can run on $U_{DC} = 12\text{ V}$ input and the ProBox can run on $U_{DC} = 12\text{--}24\text{ V}$ as well.

Will the signal go through solid objects?

Yes, the W-DMX signal will penetrate walls, glass, metal and most objects. One thing that will interrupt the signal is people. Antennas should be above

10 FAQ – Frequently asked questions

audiences to ensure reliable operation. Care need to be taken to ensure proper functionality.

Will other electronics and other W-LAN users interfere with it?

No, it is not affected by cell phones. Heavily loaded W-LAN can be a problem, care need to be taken when you can expect a high use of several W-LAN's.

How many channels of DMX does it control?

Each transmitter can control 512 channels (1 universe) of DMX, unlike some wireless systems which only have "half universe" or 256 channels. The F-2 and the ProBox can additionally control a second DMX universe.

What antenna should I use?

For most indoor applications the 2 dBi antennas work fine. Longer distances, outdoors or unique applications most likely will require different antennas. Please contact us with your intended application questions. Warranty is voided if using other antennas than W-DMX branded.

What is the transmission range?

With standard antennas the, maximum distance is 700 m/2300 feet (FCC version). As an option it's possible to connect other antenna models to achieve longer distances or where there is a specific need for higher gain. (Distances valid at 300 mW FCC)

Antenna Transmitter	Antenna Receiver	Maximum Distance
2 dBi	2 dBi	750 m
5 dBi	2 dBi	1000 m
7 dBi	5 dBi	1450 m
9 dBi	8 dBi	2300 m

How many receivers can be assigned per universe to the W-DMX in a DMX512, DMX512A, or RDM installation?

DMX Receivers is only limited to the 512 channels per universe.

If RDM is activated, you are limited to 34 RDM devices, where each W-DMX device is counted as one RDM device.

Can multiple transmitters run side by side (to support more than one universe)?

Yes, up to 8.192 receivers can be controlled from one system, and the standard configuration is with 512 DMX Channels and can easily be updated with 8.192 DMX channels (16 DMX-512 Universes).

Is it FCC approved?

Yes. Please see chapter "Technical data", page 43, 45 and 47.



Are these products UL listed?

UL pending.

What is the typical power consumption?

450 mA average, 700 mA maximum.

Please see chapter "Technical data", page 43, 45 and 47.

Is there a warranty?

All BlackBox products are covered by a standard 12 month full warranty.

Can the antenna be mounted away from the transmitter or receiver?

Yes, there are indoor and outdoor cables available in lengths from 0,5 m to 30 m (1.6 to 98 feet).

Will the receivers stay logged on to the transmitter if the DMX signal is lost?

Yes, even if the DMX signal is interrupted the receiver(s) will remain logged in.

Will the units stay logged in to each other if power is cut?

The log-in information is stored in an EEPROM and will not be erased. No battery backup is needed. In theory, the units stay logged in forever.

In an operational system, can I log on an additional receiver without disrupting DMX transmission to other receivers?

This is not possible with the BlackBox unit. Logging on an additional receiver will make the logged-in units revert to idle mode for 10 seconds; once the new units are logged-in they will all start again together with the new unit.

What is the difference between Multicast and Point to Point?

Multi-cast: transmitting to multiple receivers simultaneously.

Point to Point: data is a single path of data transmission.

What is FHSS?

Short for Frequency Hopping Spread Spectrum – Frequency hopping techniques, in which the transmitter jumps from sub-channel to sub-channel at rapid pace, were first used by the U.S. Military. Such techniques were developed precisely because they are difficult to disrupt and, unless you know the frequency hopping sequence, practically impossible to intercept. Spread spectrum techniques have two main advantages: Firstly, they are more resistant to interference than conventional systems. Secondly, they can be used to provide multiple access functionality.

Does W-DMX support on-site service with technical documentation after visit?

Wireless Solution and/or its distributors offer Cell Planning Service for larger projects. Please contact your local distributor for a quote. This is highly recommended for all larger projects to save time and money.



11 Appendix:Certificates

11 Appendix:Certificates

11.1 E1551 RFC



ФЕДЕРАЛЬНАЯ СЛУЖБА ПО НАДЗОРУ В СФЕРЕ СВЯЗИ, ИНФОРМАЦИОННЫХ ТЕХНОЛОГИЙ
И МАССОВЫХ КОММУНИКАЦИЙ

ФЕДЕРАЛЬНОЕ ГОСУДАРСТВЕННОЕ УНИТАРНОЕ ПРЕДПРИЯТИЕ
РАДИОЧАСТОТНЫЙ ЦЕНТР
ЦЕНТРАЛЬНОГО ФЕДЕРАЛЬНОГО ОКРУГА
(ФГУП «РЧЦ ЦФО»)

Ул. Достоевского, д.1/21, Москва, 127473. Тел.: (495) 258 8052, факс: (495) 688 9947
E-mail: info@rfc-cfa.ru http://www.rfc-cfa.ru
ОКПО 56562862, ОГРН 1027739054970, ИНН/КПП 7707291942/770701001

ЗАКЛЮЧЕНИЕ

О СООТВЕТСТВИИ ТЕХНИЧЕСКИХ ХАРАКТЕРИСТИК ВВОЗИМЫХ РАДИОЭЛЕКТРОННЫХ СРЕДСТВ, ВЫСОКОЧАСТОТНЫХ УСТРОЙСТВ И КОМПЛЕКТУЮЩЕГО ОБОРУДОВАНИЯ (КОМПОНЕНТОВ) ТЕХНИЧЕСКИМ ХАРАКТЕРИСТИКАМ И УСЛОВИЯМ ИСПОЛЬЗОВАНИЯ, УТВЕРЖДЕННЫМ ОБОБЩЕННЫМИ РЕШЕНИЯМИ ГОСУДАРСТВЕННОЙ КОМИССИИ ПО РАДИОЧАСТОТАМ

№ 77-12/1055/3780

От 02.11.2012

Срок действия до 02.11.2013

Выдано ООО "Элмаc" (код ОГРН – 1025007070494)

Федеральное государственное унитарное предприятие «Радиочастотный центр Центрального федерального округа» на основании результатов экспертизы подтверждает соответствие технических характеристик нижеперечисленных радиоэлектронных средств (РЭС) техническим характеристикам, утвержденным обобщенными решениями ГКРЧ, и считает возможным их ввоз из-за границы на территорию Российской Федерации.

№ п/п	Наименование РЭС		Наименование изготовителя		Количество (штук)
	Тип	Модель, платформа	Фирма	Страна	
1	Беспроводной модуль 2,4 ГГц	W-DMX TRX	Interlite AB	Швеция	1000 (одна тысяча)

Основание: решение ГКРЧ от 07.05.2007 № 07-20-03-001 "О выделении полос радиочастот устройствам малого радиуса действия".

Использование ввозимых РЭС на территории Российской Федерации должно осуществляться в соответствии с действующим законодательством Российской Федерации.

Начальник Управления по обеспечению использования радиочастот, РЭС и ВЧУ



В.В. Дихнов

11.2 ETSI Test Report

Jan Linders Ingenjörfirma	Prepared by Jan Linders	Report no. 12302RP	Rev: A
	Document date 2012-02-28	Page 4	Sign JL

Test result:

The products do comply with standard.

The test was done on a few representative objects.

Results are summarised in this chapter under Summary. More detailed descriptions from the different tests are into separate chapters.

Summary:

EUT is tested using Radio standard harmonised with the R&TTE-directive.

Summarize result tables:

Radio performance at TRX single module ETSI EN 300 328 V1.7.1			
Clause	Test	Compliant	Remarks
5.7.2	Equivalent isotropic radiated power	Yes	
5.7.3	5.7.3 Maximum e.i.r.p. spectral density	Not applicable	
5.7.4	Frequency range	Yes	
5.7.5	Transmitter spurious emissions	Yes	
5.7.6	Receiver spurious emissions	Yes	

Jan Linders Ingenjörskfirma	Prepared by Jan Linders	Report no. 12302RP	Rev: A
	Document date 2012-02-28	Page 5	Sign JL

Test House and Approval

Test house: Jan Linders Ingenjörskfirma

Location: Bror Nilssonsgata 4, 417 55 Göteborg, Sweden

Contact: Jan Linders

Telephone: +46 31 744 38 80

Mobile: + 46 707 54 38 80

e-mail: info@janlinders.com

Testing is performed by: Jan Linders

Customer representative: Samuel Eriksson

Test facilities

Short test site definition of the used test facilities:

MR1: Semi anechoic chamber, 10*6*6 meters. Calibrated for radiated emission and immunity.

MRT1: Shielded room, 7*4,5*2,5 meters. Used for transient and conducted testing.

MFPA: Site for power and low frequencies. A lot of combinations between voltage, amperes and frequencies can be achieved.

MAC4: Small anechoic chamber for investigating purposes.

Approval

We declare that the tested unit(s) is in accordance with the results and specifications in this report. The test yields for the tested item(s)

Jan Linders

2012-02-06
Date

11.3 GRANT OF EQUIPMENT AUTHORIZATION

TCB

GRANT OF EQUIPMENT
AUTHORIZATION

TCB

Certification
Issued Under the Authority of the
Federal Communications Commission
By:

Intertek Testing Services NA, Inc.
70 Codman Hill Road
Boxborough, MA 01719

Date of Grant: 09/04/2012
Application Dated: 08/17/2012

Interlite AB
Interlite AB
Stureparksvägen 7
Uddevalla, 451 55
Sweden

Attention: Niclas Arvidsson , CEO

NOT TRANSFERABLE

EQUIPMENT AUTHORIZATION is hereby issued to the named GRANTEE,
and is VALID ONLY for the equipment identified hereon for use under the
Commission's Rules and Regulations listed below.

FCC IDENTIFIER: NY2-WDMXTRX

Name of Grantee: Interlite AB

Equipment Class: Part 15 Spread Spectrum Transmitter

Notes: FHSS radio transceiver for DMX communication

in lighting industry

Modular Type: Single Modular

<u>Grant Notes</u>	<u>FCC Rule Parts</u>	<u>Frequency Range (MHz)</u>	<u>Output Watts</u>	<u>Frequency Tolerance</u>	<u>Emission Designator</u>
	15C2402.0	0 - 2459.0	0.0851		

Modular approval. Output power is conducted. The antenna(s) used for this transmitter must be installed to provide a separation distance of at least 20 cm from all persons and must not be co-located operating in conjunction with any other antenna or transmitter. Users and installers must be provided with antenna installation instructions and transmitter operating conditions for satisfying RF exposure compliance.

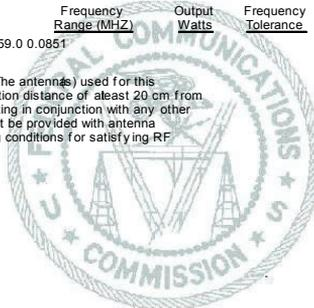

WIRELESS SOLUTION
MADE IN SWEDEN



Wireless Solution Sweden Sales AB

Stureparksvägen 7
451 55 Uddevalla
Sweden

Tel.: +46 522 511 511

Fax: +46 522 440 885

E-Mail: helpdesk@wirelessdmx.com

Web: www.wirelessdmx.com

G4 **W-DMX** **S**
GENERATION IV